

**VALVOLE A SFERA**

*BALL VALVES*

*KUGELHÄHNE*

*ROBINETS A BOISSEAU SPHÉRIQUE*

*VÁLVULAS A ESFERA*















































*VÁLVULAS DE ESFERA*



**Serie Ghilux**

Aignep si riserva il diritto di variare modelli e ingombri senza preavviso - Aignep reserves the right to vary models and dimensions without notice - Aignep behält sich das Recht vor, Daten ohne Ankündigung zu ändern  
Aignep se réserve le droit de modifier les données sans préavis - Aignep se reserva el derecho de modificar modelos y dimensiones sin previo aviso - Aignep reserva-se o direito de alterar os modelos e dimensões sem prévio aviso

Aggiornamento - Updated - Stand - Updated - Atualização - 09/2016

 <b>6300</b> Pag. 12.9	 <b>6310</b> Pag. 12.9	 <b>6320</b> Pag. 12.9	 <b>6330</b> Pag. 12.	 <b>6340</b> Pag. 12.10	 <b>6350</b> Pag. 12.10	 <b>6400</b> Pag. 12.10	 <b>6410</b> Pag. 12.10	 <b>6420</b> Pag. 12.11
 <b>6430</b> Pag. 12.11	 <b>6440</b> Pag. 12.11	 <b>6450</b> Pag. 12.12	 <b>6460</b> Pag. 12.12	 <b>6470</b> Pag. 12.12	 <b>6490</b> Pag. 12.13	 <b>6500</b> Pag. 12.13	 <b>6540</b> Pag. 12.13	 <b>6560</b> Pag. 12.14
 <b>6570</b> Pag. 12.14	 <b>6600</b> Pag. 12.14	 <b>86300</b> Pag. 12.15	 <b>86310</b> Pag. 12.15	 <b>66300</b> Pag. 12.17	 <b>66310</b> Pag. 12.17	 <b>6700</b> Pag. 12.19	 <b>6710</b> Pag. 12.20	 <b>6720</b> Pag. 12.20
 <b>6900</b> Pag. 12.21	 <b>6910</b> Pag. 12.21	 <b>6915</b> Pag. 12.22	 <b>6920</b> Pag. 12.22	 <b>6680</b> Pag. 12.23	 <b>10740</b> Pag. 12.23	 <b>10741</b> Pag. 12.23	 <b>10760</b> Pag. 12.23	 <b>10761</b> Pag. 12.23
 <b>6065</b> Pag. 12.25	 <b>6066</b> Pag. 12.25	 <b>6067</b> Pag. 12.27	 <b>6068</b> Pag. 12.27	 <b>6069</b> Pag. 12.28	 <b>New</b> <b>6074</b> Pag. 12.31	 <b>New</b> <b>6075</b> Pag. 12.32	 <b>6035</b> Pag. 12.33	 <b>6036</b> Pag. 12.35
 <b>6037</b> Pag. 12.35	 <b>6038</b> Pag. 12.35							

Inventate e ingegnerizzate da Aignep le valvole a sfera Ghilux sono state una rivoluzione già negli anni 90'. Di minimi ingombri e performanti queste micro valvole sono la risposta ottimale alla crescente richiesta di miniaturizzazione. Disponibili a 2 e 3 vie, con sfianto e attraversamento parete sono disponibili in ben 25 modelli differenti, possono intercettare differenti tipologie di fluidi. Possibilità di realizzare rubinetti con tenute differenti in FKM, EPDM e HNBR. Versione in Aisi 316L. A completamento dell'offerta Aignep dispone di rubinetti a 2 e 3 vie di dimensioni tradizionali.

### Principali vantaggi

- A 2 e 3 vie e con spurgo
- Da 1/8 a 3/4 nelle filettature BSPP, BSPT e NPT
- Passaparete
- Tenute differenti in base alle applicazioni
- Leggerezza ed ingombro ridotto
- Inserti intercambiabili colorati per identificazione
- Silicon Free

### Applicazioni

- Aria Compressa e Strumenti
- Automazione Pneumatica
- Intercettazione Fluidi
- Food & Beverage
- Life & Sciences
- Gas Inerti, vuoto
- Settore Termoidraulico

The GHILUX miniature ballvaves have been created and engineered by Aignep in the 90's. The supercompact dimensions and the excellent performance respond to the growing demand of miniaturization.

Many available version: 2 or 3-ways, with exhaust, push-in, compression, etc.

25 different configurations to drive multiple fluids. On demand FKM, EPDM e HNBR.

To complete the range traditional ball valves.

### Main advantages

- 2-3 ways with exhaust
- Threads 1/8 to 3/4" - BSPP, BSPT, NPT
- Bulkhead
- Multiple fluids
- Supercompact dimension
- Coloured plates for Identification
- Silicon Free

### Applications

- Compressed Air, Tools
- Pneumatic Automation
- Fluidtechnology
- Food & Beverage
- Life & Sciences
- Inert Gases, Vacuum
- Plumbing

Die GHILUX Miniatur-Kugelhähne wurden in den 90er Jahren von Aignep entwickelt und kreiert.

Die superkompakten Abmessungen und die ausgezeichnete Leistung antworten auf die wachsende Nachfrage nach Miniaturisierung. Viele erhältliche Versionen: 2 oder 3-Wege, mit Entlüftung, mit Steckanschluss, etc.

25 verschiedene Konfigurationen für den Transport vieler Medien. Auf Anfrage FKM, EPDM und HNBR Dichtungen. Als Ergänzung zum traditionellen Kugelhahn Sortimenten.

### Hauptvorteile

- 2-3 Wege mit Entlüftung
- Gewinde 1/8 bis 3/4" - BSPP, BSPT, NPT
- Schottmontage
- Verschiedene Medien
- Superkompakte Abmessung
- Farbige Schilder zur Kennzeichnung
- Silikonfrei

### Anwendungen

- Druckluft, Werkzeuge
- Pneumatische Automation
- Fluidtechnik
- Lebensmittel & Getränke
- Life Sciences
- Inertgase, Vakuum
- Sanitär

Les robinets à boisseau sphérique GHILUX ont été conçus par Aignep dans les années 90. L'extrême compacité et l'excellente performance des produits répondent aux demandes croissantes dans la miniaturisation. Nombreuses versions disponibles: 2 ou 3 voies, avec échappement, raccordement instantané, à olive, etc. 25 configurations différentes pour transporter différents fluides. Version avec joint FKM, EPDM HNBR sur demande. Les robinets GHILUX complètent notre offre de robinets standards à boisseau sphérique.

### Principaux avantages

- 2-3 voies, male -femelle- avec échappement
- Filetages de 1/8 à 3/4 - BSPP, BSPT, NPT
- A traversée de cloison
- Nombreux fluides
- Extrême compacité
- Plaques de couleur pour l'identification des circuits
- Sans Silicone

### Applications

- Air comprimé
- Automatisatismes pneumatiques
- Agro alimentaire
- Laboratoire
- Gaz neutres, vide
- Plomberie

Inventadas y desarrolladas por Aignep las válvulas de esfera Ghilux eran ya una revolución en los años 90'. De reducidas dimensiones y excelente rendimiento estas micro válvulas son la respuesta óptima a la creciente demanda de miniaturización. Disponibles de 2 y 3 vías, con escape, automáticas, pasatabiques, compresión, 25 diferentes configuraciones para interceptar diferentes tipologías de fluidos. Posibilidad bajo demanda en FKM, EPDM y HNBR. Versión en Inox AISI 316L. Para completar la gama Aignep dispone de válvulas de esfera 2 y 3 vías de dimensiones tradicionales.

### Principales ventajas

- A 2 y 3 vías y con escape
- De 1/8 a 3/4 con roscas BSPP, BSPT y NPT
- Pasatabiques
- Estanqueidad diferente en base a las aplicaciones
- Ligereza y dimensiones reducidas
- Insertos intercambiables de color para identificación
- Libres de silicona

### Aplicaciones

- Aire comprimido y herramientas
- Automatización neumática
- Intercettazione de fluidos
- Alimentos y bebidas
- Life & Sciences
- Gases inertes, vacío
- Sector termo hidráulico

As válvula-esfera miniatura da série GHILUX foram criadas e desenvolvidas pela Aignep nos anos 90. As dimensões super-compactas e a excelente performance, atende ao crescimento de demanda de miniaturização solicitada pelo mercado moderno. Várias versões estão disponíveis: 2 ou 3-vias, com exaustão, conexão push-in, conexão de compressão, etc. 25 configurações diferentes para conduzir múltiplos fluidos. Sob encomenda: vedações em FKM, EPDM e HNBR para completar o range tradicional das válvulas-esfera.

### Principais vantagens

- 2-3 vias com escape
- Roscas de 1/8 a 3/4 - BSPP, BSPT, NPT
- Modelo passa-muro
- Múltiplos fluidos
- Dimensões Super-compactas
- Linguetas coloridas para fácil identificação
- Livre de Silicone

### Aplicações

- Ar Comprimido, Ferramentas
- Automação Pneumática
- Fluidos
- Alimentos e Bebida
- Life & Sciences
- Gases Inertes, Vácuo
- Encanamento



**CARATTERISTICHE TECNICHE**  
 TECHNICAL CHARACTERISTICS  
 TECHNISCHE ANGABEN  
 CARACTÉRISTIQUES TECHNIQUES  
 CARACTERÍSTICAS TÉCNICAS  
 CARACTERÍSTICAS TÉCNICAS



**Norma di Riferimento**

Reference standard

Entspricht der Norm

Norme de référence

Normativa de referencia

Norma de referência

1907/2006

REACH ✓

2011/65/CE

RoHS ✓

PED

2014/68/UE

BS EN 331:2015

SILICON FREE

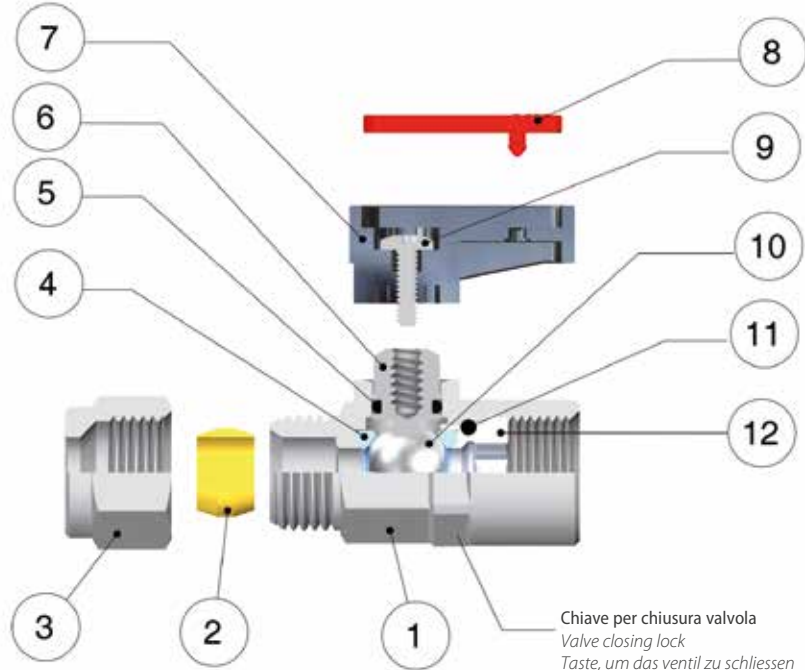

Chiave per chiusura valvola  
 Valve closing lock  
 Taste, um das Ventil zu schliessen  
 Clé pour vanne de fermeture  
 Llave para el cierre de la válvula  
 A chave para o fecho da válvula

**FKM - EPDM - HNBR A RICHIESTA**  
 IF REQUESTED FKM - EPDM - HNBR  
 FKM - EPDM - HNBR AUF ANFRAGE  
 FKM - EPDM - HNBR SUR DEMANDE  
 FKM - EPDM - HNBR BAJO PEDIDO  
 FKM - EPDM - HNBR SOB ENCOMENDA

**Materiali e Componenti**

**IT**

- 1 Corpo in Ottone cromato
- 2 Ogiva in Ottone (PTFE a richiesta)
- 3 Dado in Ottone cromato
- 4 Guarnizione sede sfera in PTFE
- 5 Guarnizione O-RING in NBR (FKM-EPDM-HNBR a richiesta)
- 6 Albero in Ottone cromato
- 7 Maniglia in PA66 Caricato vetro
- 8 Piastrina in Resina Acetalica
- 9 Vite in acciaio
- 10 Sfera in Ottone cromato
- 11 Guarnizione O-RING in NBR (FKM-EPDM-HNBR a richiesta)
- 12 Ghiera o raccordo in Ottone

**Component Parts and Materials**

**GB**

- 1 Chrome Nickel-plated Brass Body
- 2 Brass Olive (if requested PTFE)
- 3 Chrome Nickel-plated Brass Nut
- 4 PTFE Seats
- 5 NBR Seal O-RING (FKM-EPDM-HNBR if required)
- 6 Chrome Nickel-plated Brass Spindle
- 7 PA66 Glass reinforced Handle
- 8 Acetalic resin Plate
- 9 Steel Screw
- 10 Chrome Nickel-plated Brass Ball
- 11 NBR Seal O-RING (FKM-EPDM-HNBR if required)
- 12 Brass Fitting

**Komponenten und Materialien**

**DE**

- 1 Körper Messing verchromt
- 2 Klemmring Messing (PTFE auf Anfrage)
- 3 Überwurfmutter Messing verchromt
- 4 Kugelsitzdichtung PTFE
- 5 O-Ring NBR (FKM-EPDM-HNBR auf Anfrage)
- 6 Spindel Messing verchromt
- 7 Handgriff PA66 Glasfaser verstärkt
- 8 Griffplatte Acetal
- 9 Schraube Stahl
- 10 Kugel Messing verchromt
- 11 O-Ring NBR (FKM-EPDM-HNBR auf Anfrage)
- 12 Gewindeinsatz Messing

**Matériaux et Composants**

**FR**

- 1 Corps: laiton chromé
- 2 Bague: laiton (sur demande en PTFE)
- 3 Ecrou: laiton nickelé
- 4 Joint bille sphérique: PTFE
- 5 Joint tige NBR (sur demande en FKM-EPDM-HNBR)
- 6 Tige: laiton chromé
- 7 Poignée en PA66 chargé en fibre de verre
- 8 Plaquette de poignée: résine acétal
- 9 Vis: acier
- 10 Bille: laiton chromé
- 11 Joint torique NBR (sur demande en FKM-EPDM-HNBR)
- 12 Ecrou de blocage: laiton

**Materiales y Componentes**

**ES**

- 1 Cuerpo en latón cromado
- 2 Bicono en latón (PTFE bajo demanda)
- 3 Tuerca en latón cromado
- 4 Junta sede esfera en PTFE
- 5 Junta tórica O-RING en NBR (FKM-EPDM-HNBR bajo demanda)
- 6 Eje en latón cromado
- 7 Maneta en PA66 con fibra de vidrio
- 8 Plaqueta en PA6
- 9 Tornillo en acero
- 10 Esfera en latón cromado
- 11 Junta tórica O-RING en NBR (FKM-EPDM-HNBR bajo demanda)
- 12 Racor en latón

**Materiais e Componentes**

**PT**

- 1 Corpo em Latão Cromado
- 2 Bucha em Latão (PTFE sob encomenda)
- 3 Porca em Latão Cromado
- 4 Vedação da sede da esfera em PTFE
- 5 Vedação O-RING em NBR (FKM-EPDM-HNBR sob encomenda)
- 6 Eixo em Latão Cromado
- 7 Manopla em PA66 e fibra de vidro
- 8 Piaqueta de Resina Acetalica
- 9 Parafuso em aço
- 10 Esfera em Latão Cromado
- 11 Vedação O-RING em NBR (FKM-EPDM-HNBR sob encomenda)
- 12 Conexões em Latão



### Temperature

Temperatures  
Temperatur  
Températures  
Temperaturas  
Temperaturas

- 20 °C	FKM	EPDM	HNBR
+ 80 °C	- 15 °C	- 40 °C	- 30 °C
	+ 130 °C	+ 130 °C	+ 130 °C



### Pressioni

Pressures  
Druckbereich  
Pressions  
Presiones  
Pressões

-0.99 bar (-0.099 MPa)  
20 bar (2 MPa)

### DIAGRAMMA PRESSIONE - TEMPERATURA

PRESSURE - TEMPERATURE RATINGS DIAGRAM  
DRUCK - TEMPERATUR DIAGRAMM  
DIAGRAMME PRESSION - TEMPÉRATURE  
DIAGRAMA PRESIÓN-TEMPERATURA  
DIAGRAMA DE PRESSÃO-TEMPERATURA

PTFE + FKM

PTFE + NBR

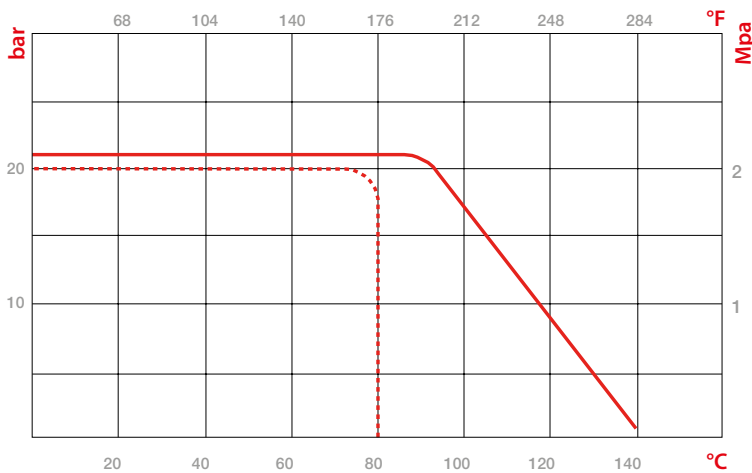

### Fluidi compatibili

Aria compressa / Acqua / Oli  
1ª e 2ª famiglia di gas a media pressione.  
3ª famiglia di gas a bassa pressione.

### Fluids

Compressed air / Water / Oils

1st and 2nd family gases at medium pressure.  
3rd family gases at low pressure.

### Geeignete Medien

Druckluft / Wasser / Öl

1. und 2. Familie von Gasen für Mitteldruck.  
3. Familie von Gasen für Niederdruck.

### Fluides compatibles

Air comprimé / Eau / Huile

Famille 1 et 2 des gaz à moyenne pression.  
Famille 3 des gaz à basse pression.

### Fluidos compatibles

Aire comprimido / Agua / Aceite

1ª y 2ª familia de gases a media presión.  
3ª familia de gas a baja presión.

### Fluidos compatíveis

Ar comprimido / Água / Óleos

1ª e 2ª família de gás a média pressão.  
3ª família de gás a baixa pressão.



### Filettatura

Gas conforme ISO 7.1, BS 21, DIN 2999  
Gas cilindrica conforme ISO 228 Classe A.

### Threads

Gas in conformity with ISO 7.1, BS 21, DIN 2999.  
Parallel gas in conformity with ISO 228 Class A.

### Gewindearten

Gewinde nach Norm ISO 7.1, BS 21, DIN 2999.  
Zylindrisches Gewinde nach Norm ISO 228 Classe A.

### Filetages

Filetage conforme: ISO 7.1, BS 21, DIN 2999.  
Filetage cylindrique conforme: ISO 228 Class A.

### Roscas

Gas conforme ISO 7.1, BS 21, DIN 2999  
Gas cilíndrica conforme ISO 228 Clase A.

### Roscas

Gas conforme ISO 7.1, BS 21, DIN 2999.  
Gas paralela conforme ISO 228 Classe A.

**CURVE CARATTERISTICHE DI FLUSSO PER ARIA RELATIVE ALLE VALVOLE A SFERA GHILUX ART. 6400 FEMMINA-FEMMINA**

CHARACTERISTIC CURVES OF FLOW FOR AIR PERTINENT TO THE BALL VALVES GHILUX ART. 6400 FEMALE-FEMALE

DURCHFLOSSKENNLINIEN FÜR DRUCKLUFT ANGEGEBEN FÜR DIE KUGELHÄHNE GHILUX ART. 6400 INNEN-/INNENGEWINDE

DIAGRAMME DE VALEUR DU DEBIT POUR ROBINET GHILUX ART. 6400

CURVA CARACTERÍSTICA DE FLUJO PARA AIRE RELATIVO A LAS VÁLVULAS A ESFERA GHILUX ART.6400 HEMBRA-HEMBRA

CURVAS CARACTERÍSTICAS DE VAZÃO PARA AR RELATIVAS ÀS VÁLVULAS DE ESFERA GHILUX CÓD. 6400 FÊMEA-FÊMEA

**NI/min**

Portata  
Flow rate  
Durchfluss  
Débit  
Caudal  
Vazão

**P1 (bar)**

Pressione di entrata  
Inlet Pressure  
Eingangsdruck  
Pression d'entrée  
Presión de entrada  
Pressão de entrada

**P2 (bar)**

Pressione di uscita  
Outlet Pressure  
Ausgangsdruck  
Pression de sortie  
Presión de salida  
Pressão de saída

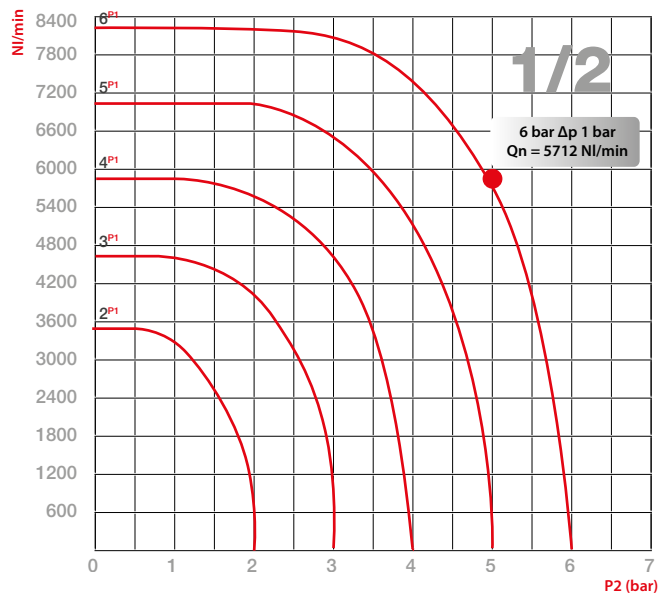
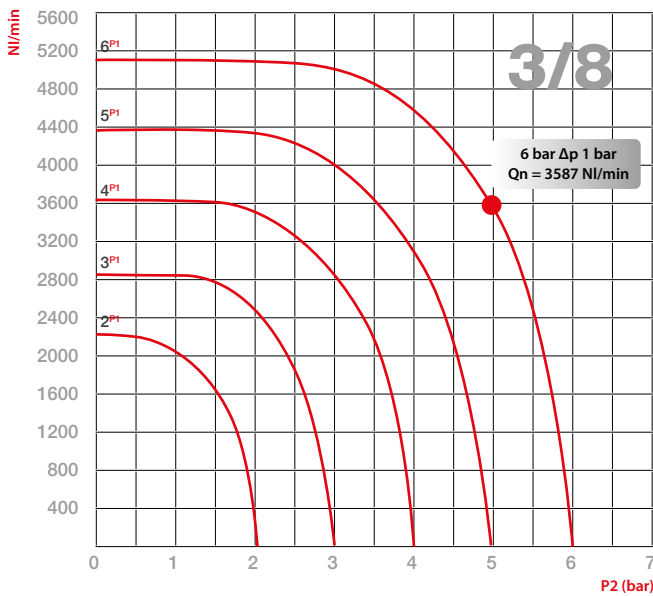
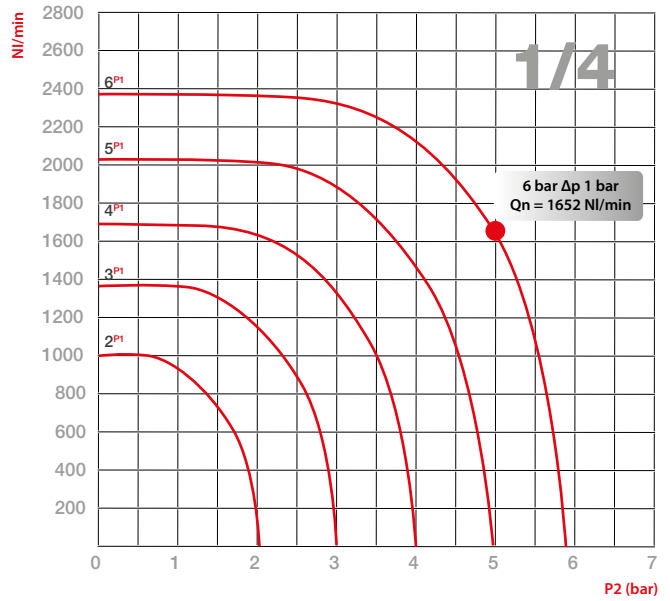
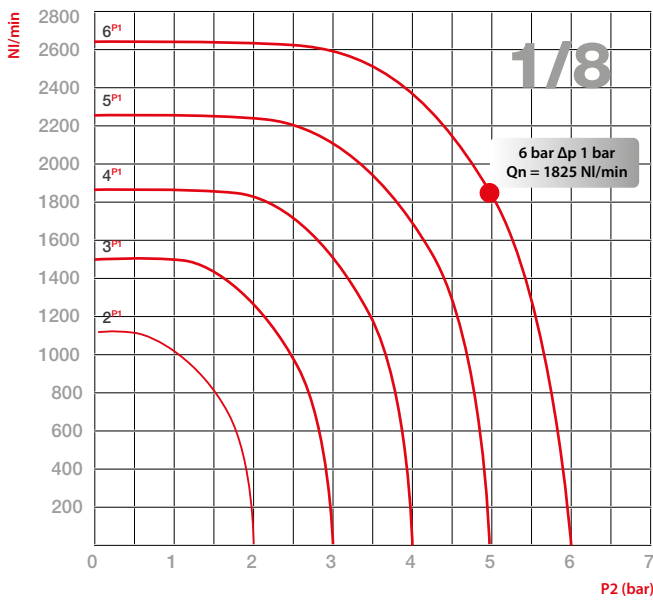

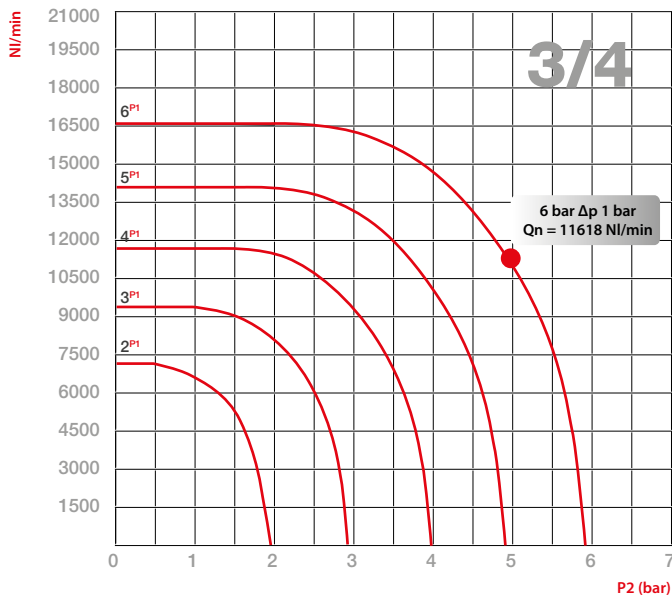

**DIAGRAMMA DELLA CARATTERISTICA PORTATA-PERDITA DI CARICO RELATIVO ALLE VALVOLE A SFERA GHILUX ART. 6400 FEMMINA-FEMMINA PER ACQUA**

DIAGRAM OF THE FLOW RATE AND PRESSURE DROP CHARACTERISTICS PERTINENT TO THE BALL VALVES GHILUX ART. 6400 FEMALE-FEMALE FOR WATER  
 DURCHFLOSS- UND DRUCKABFALLDIAGRAMM FÜR WASSER ANGEZEIGT FÜR DIE KUGELHÄHNE GHILUX ART. 6400 INNEN-/INNENGEWINDE  
 DIAGRAMME DEBIT ET PERTE DE CHARGE POUR ROBINET GHILUX ART. 6400 FEMELLE/FEMELLE  
 DIAGRAMA DE LAS CARACTERÍSTICAS CAUDAL-PÉRDIDA DE CARGA RELATIVO A LAS VÁLVULAS A ESFERA ART.6400 HEMBRA-HEMBRA PARA AGUA  
 DIAGRAMA DA CARACTERÍSTICA DE VAZÃO-PERDA DE CARGA RELATIVO ÀS VÁLVULAS DE ESFERA GHILUX CÓD. 6400 FÊMEA-FÊMEA PARA ÁGUA

**ΔP (DAPA)**

Perdita di carico  
 Pressure drop  
 Druckabfall  
 Perte de charge  
 Pérdida de carga  
 Perda de carga

1 DAPA = 1,019 mm H<sub>2</sub>O

**Kv (Kg/h)**

Portata  
 Flow rate  
 Durchfluss  
 Débit  
 Caudal  
 Vazão

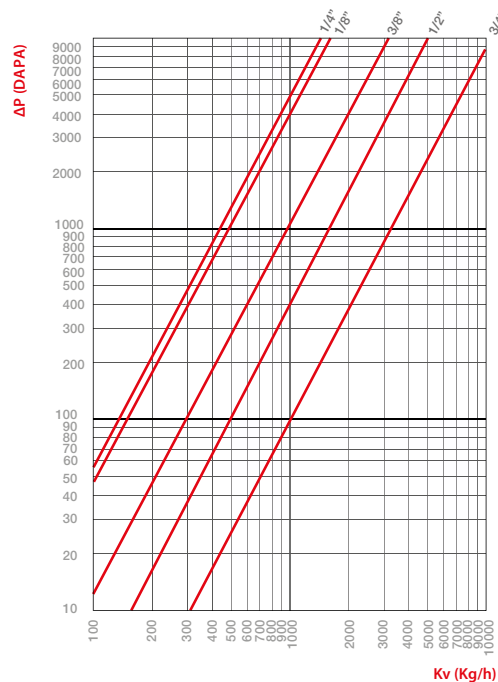

Misura Size Größe Dimension Medida Tamanho	Coefficiente di portata idraulica Factor of Hydraulic flow rate Hydraulische Durchflusskoeffizienten Coefficient du débit hydraulique Coeficiente de caudal hidráulico Coeficiente de vazão hidráulica	
	Kv (Kg/h)	m <sup>3</sup> /h
1/8"	1614	1,6
1/4"	1461	1,4
3/8"	3164	3,1
1/2"	5051	5
3/4"	10274	10,2

**Coefficienti di Portata Kv**

IT

Ripartiamo in tabella il coefficiente di portata **Kv** delle valvole a sfera GHILUX, ricordando che tale coefficiente rappresenta la quantità d'acqua che attraversa la valvola nell'unità di tempo (Kg/h) alla temperatura di 15,5° C e che determina una caduta di pressione unitaria.

**Flow Rate Factors Kv**

GB

On the following table we specify the flow rate factor **Kv** of the ball valves GHILUX, we remind You that this factor represent the quantity of water that cross the valve in the unit time (Kg/h) at the temperature of 15,5° C and it determines a drop of unitary pressure.

**Durchflusskoeffizienten Kv**

DE

Die folgende Tabelle zeigt den Durchflusskoeffizienten **Kv** der GHILUX Kugelhähne. Dieser Faktor steht für die Wassermenge, welche den Kugelhahn in der Zeiteinheit (Kg/h) bei einer Temperatur von ca. 15,5° C durchfließt und er bestimmt einen einheitlichen Druckabfall.

**Coefficient de Débit Kv**

FR

Les valeurs **Kv** mentionnées sous le tableau sont valables pour les robinets GHILUX. Nous rappelons que le coefficient Kv représente la quantité d'eau traversant le robinet dans l'unité de temps (Kg/h) à la température de 15,5°C déterminant une perte de charge unitaire.

**Coefficientes de Caudal Kv**

ES

Representamos en la tabla los coeficientes de caudal **Kv** de las válvulas a esfera serie GHILUX, recordando que este coeficiente representa la cantidad de agua que pasa por la válvula por unidad de tiempo (Kg/h) a la temperatura de 15,5° C y que determina una caída de presión unitaria.

**Coefficientes de Vazão Kv**

PT

Especificamos na tabela a seguir o coeficiente de vazão **Kv** das válvulas de esfera GHILUX, recordando que tal coeficiente representa a quantidade de água que atravessa a válvula na unidade de tempo (Kg/h) a uma temperatura de 15,5° C e que determina uma queda de pressão unitária.

**Opzioni**

Option

Optionen

Options

Opciones

Opções

 CODICE ARTICOLO  
 ARTICLE CODE  
 ARTIKEL-NUMMER  
 CODE ARTICLE  
 CÓDIGO ARTÍCULO  
 CÓDIGO DO PRODUTO

 MISURA  
 SIZE  
 GRÖSSE  
 DIMENSIONS  
 MEDIDA  
 TAMANHO

 COLORE PIASTRINA  
 COLOUR OF THE PLATE  
 GRIFFPLATTEN FARBEN  
 COULEUR DE LA PLAQUETTE  
 COLOR PLAQUETA  
 COR PLAQUETA

 TIPO DI GUARNIZIONE  
 TYPE OF THE SEAL  
 ART DER DICHTUNG  
 TYPE DE JOINT  
 TIPO DE JUNTA  
 TIPO DE VEDAÇÃO

 TIPO MANIGLIA  
 TYPE OF HANDLES  
 ART DES HANDGRIFFES  
 TYPE DE POIGNÉE  
 TIPO DE MANETA  
 TIPO DE MANETA

 TIPO DI OGIVA  
 TYPE OF OLIVE  
 ART DES KLEMMRINGES  
 TYPE DE BAGUE  
 TIPO DE BICONO  
 TIPO DE BUCHA

**6430**
**3/8-3/8**
**RED PLATE**
**NBR**
**BRASS Olive**

 Piastrina Rossa  
 Red Plate  
 Griffplatte Rot  
 Plaquette Rouges  
 Plaqueta Roja  
 Plaqueta Vermelha

**NBR**

**Maniglia CORTA STANDARD per valvola da 1/8 - 1/4 - 3/8 - 1/2**  
**Maniglia LUNGA STANDARD per Valvola da 3/4**

 Standard SHORT Handle for Valve 1/8-1/4-3/8-1/2  
 Standard LONG Handle for Valve 3/4

 Handgriff KURZ Standard für 1/8-1/4-3/8-1/2  
 Handgriff LANG Standard für 3/4

 Poignée COURTE en standard pour 1/8-1/4-3/8-1/2  
 Poignée LONGUE en standard pour 3/4

 Maneta CORTA estándar para válvula de 1/8-1/4 -3/8-1/2  
 Maneta LARGA estándar para válvula de 3/4

 Manopla CURTA standard para válvula de 1/8-1/4-3/8- 1/2  
 Manopla LONGA standard para válvula de 3/4

**Ogiva OTTONE**  
 Brass OLIVE  
 Klemmring MESSING  
 Bague LAITON  
 Bicoño LATÓN  
 Bucha em LATÃO

 Su richiesta  
 If required  
 Auf Anfrage  
 Sur demande  
 Bajo demanda  
 Sob encomenda

 Piastrina Blu  
 Blue Plate  
 Griffplatte Blau  
 Plaquette Bleu  
 Plaqueta Azul  
 Plaqueta Azul

 Piastrina Verde  
 Green Plate  
 Griffplatte Grün  
 Plaquette Verte  
 Plaqueta Verde  
 Plaqueta Verde

 Piastrina Bianca  
 White Plate  
 Griffplatte Weiss  
 Plaquette Blanche  
 Plaqueta Blanca  
 Plaqueta Branca

 Piastrina Gialla  
 Yellow Plate  
 Griffplatte Gelb  
 Plaquette Jaune  
 Plaqueta Amarela  
 Plaqueta Amarela

**GAS:**

 Piastrina Gialla EN 331  
 Yellow Plate EN 331  
 Griffplatte Gelb EN 331  
 Plaquette Jaune EN 331  
 Plaqueta Amarilla EN 331  
 Plaqueta Amarela EN 331

**FKM  
HNBR  
EPDM**

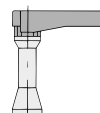
**Maniglia LUNGA**  
 LONG Handle  
 Handgriff LANG  
 Poignée LONGUE  
 Maneta LARGA  
 Manopla LONGA

**Maniglia LUNGA con Prolunga albero di comando**

 Long HANDLE with Spindle Extension  
 Handgriff LANG mit verlängerter Schaltwelle

Poignée LONGUE avec arbre rallongé

 Maneta LARGA prolongada  
 Manopla LONGA com Prolongamento no eixo de comando

**Ogiva PTFE**  
 PTFE Olive  
 Klemmring PTFE  
 Bague PTFE  
 Bicoño PTFE  
 Bucha em PTFE



### 6300

#### VALVOLA FEMMINA RP ISO 7 - FEMMINA RP ISO 7

FEMALE RP ISO 7 - FEMALE RP ISO 7 VALVE  
 KUGELHAHN INNENGEW. RP ISO 7 - INNENGEW. RP ISO 7  
 ROBINET - TARAUDAGE RP ISO 7  
 VÁLVULA HEMBRA RP ISO 7 - HEMBRA RP ISO 7  
 VÁLVULA ROSCA FÊMEA RP ISO 7 - ROSCA FÊMEA RP ISO 7

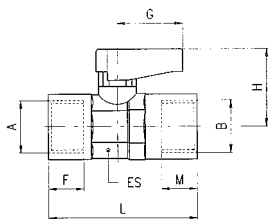

Code	A	B	DN	ES	F	M	L	G	H	Pack.
06300 00 001	1/8	1/8	5.5	14-15	7.4	7.4	36	19	21	10
06300 00 002	1/4	1/4	5.5	14-15	11	11	43	19	21	10
06300 00 003	3/8	3/8	8	18-19	11.4	11.4	47	19	22	10
06300 00 004	1/2	1/2	10	22-23	15	15	59	26	30.5	10
06300 00 055	3/4	3/4	14	28-30	16.3	16.3	67	50	33	5

### 6310

#### VALVOLA MASCHIO CONICO R ISO 7 - FEMMINA RP ISO 7

TAPER MALE R ISO 7 - FEMALE RP ISO 7 VALVE  
 KUGELHAHN AUSSENGEW. KONISCH R ISO 7 - INNENGEW. RP ISO 7  
 ROBINET FILETAGE R ISO 7 - TARAUDAGE RP ISO 7  
 VÁLVULA MACHO CÔNICO R ISO 7 - HEMBRA RP ISO 7  
 VÁLVULA ROSCA MACHO CÔNICA R ISO 7 - ROSCA FÊMEA RP ISO 7

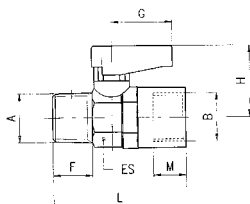

Code	A	B	DN	ES	F	M	L	G	H	Pack.
06310 00 001	1/8	1/8	5.5	14-15	7.4	7.4	36	19	21	10
06310 00 002	1/4	1/8	5.5	14-15	11	7.4	40.5	19	21	10
06310 00 003	1/4	1/4	5.5	14-15	11	11	43	19	21	10
06310 00 004	3/8	3/8	8	18-19	11.4	11.4	46	19	22	10
06310 00 005	1/2	1/2	10	22-23	15	15	57	26	30.5	10
06310 00 066	3/4	3/4	14	28-30	16.3	16.3	63	50	33	5

### 6320

#### VALVOLA MASCHIO CILINDRICO GA ISO 228 - FEMMINA RP ISO 7

PARALLEL MALE GA ISO 228 - FEMALE RP ISO 7 VALVE  
 KUGELHAHN AUSSENGEW. ZYLINDRISCH GA ISO 228 - INNENGEW. RP ISO 7  
 ROBINET FILETAGE R ISO 228 - TARAUDAGE RP ISO 7  
 VÁLVULA MACHO CILÍNDRICO GA ISO 228 - HEMBRA RP ISO 7  
 VÁLVULA ROSCA MACHO PARALELA GA ISO 228 - FÊMEA RP ISO 7

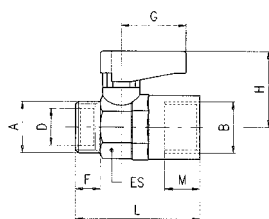

Code	A	B	DN	ES	D	F	M	L	G	H	Pack.
06320 00 001	1/8	1/8	5.5	14-15	6.2	7	7.4	34.5	19	21	10
06320 00 002	1/4	1/8	5.5	14-15	8.2	8	7.4	35.5	19	21	10
06320 00 003	1/4	1/4	5.5	14-15	8.2	8	11	38	19	21	10
06320 00 004	3/8	3/8	8	18-19	10.2	9	11.4	41.5	19	22	10
06320 00 005	1/2	1/2	10	22-23	15.2	10	15	50	26	30.5	10
06320 00 066	3/4	3/4	14	28-30	18.2	12	16.3	56.5	50	33	5

### 6330

#### VALVOLA MASCHIO CONICO R ISO 7 - MASCHIO CILINDRICO GA ISO 228

TAPER MALE R ISO 7 - PARALLEL MALE GA ISO 228 VALVE  
 KUGELHAHN AUSSENGEW. KONISCH R ISO 7 - AUSSENGEW. ZYLINDRISCH GA ISO 228  
 ROBINET FILETAGE R ISO 7 - FILETAGE GA ISO 228  
 VÁLVULA MACHO CÔNICO R ISO 7 - MACHO CILÍNDRICO GA ISO 228  
 VÁLVULA ROSCA MACHO CÔNICA R ISO 7 - ROSCA MACHO PARALELA GA ISO 228

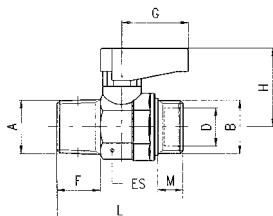

Code	A	B	DN	ES	D	F	M	L	G	H	Pack.
06330 00 001	1/8	1/8	5.5	14-15	6.2	7.4	7	33.5	19	21	10
06330 00 002	1/8	1/4	5.5	14-15	8.2	7.4	8	33.5	19	21	10
06330 00 003	1/4	1/8	5.5	14-15	6.2	11	7	38	19	21	10
06330 00 004	1/4	1/4	5.5	14-15	8.2	11	8	38	19	21	10
06330 00 005	3/8	3/8	8	18-19	10.2	11.4	9	41.5	19	22	10
06330 00 006	1/2	1/2	10	22-23	15.2	15	10	49	26	30.5	10
06330 00 077	3/4	3/4	14	28-30	18.2	16.3	12	55.5	50	33	5

### 6340

**VALVOLA TUBO - FEMMINA RP ISO 7**

TUBE - FEMALE RP ISO 7 VALVE  
 KUGELHAHN ROHR - INNENGEW. G ISO 228  
 ROBINET TUBE - TARAUDAGE RP ISO 7  
 VÁLVULA TUBO - HEMBRA RP ISO 7  
 VÁLVULA TUBO - ROSCA FÊMEA RP ISO 7

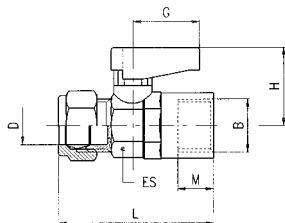

Code	D	B	DN	ES	M	L	G	H	Pack.
06340 00 001	6	1/8	5.5	14-15	7.4	41.5	19	21	10
06340 00 002	8	1/8	5.5	14-15	7.4	43	19	21	10
06340 00 003	8	1/4	5.5	14-15	11	46	19	21	10
06340 00 004	10	3/8	8	18-19	11.4	50.5	19	22	10
06340 00 005	12	3/8	8	18-19	11.4	51.5	19	22	10
06340 00 006	14	1/2	10	22-23	15	61.5	26	30.5	10
06340 00 007	15	1/2	10	22-23	15	61.5	26	30.5	10
06340 00 098	16	3/4	14	28-30	16.3	68	50	33	5
06340 00 099	18	3/4	14	28-30	16.3	68	50	33	5

### 6350

**VALVOLA MASCHIO CONICO R ISO 7 - TUBO**

TAPER MALE R ISO 7 - TUBE VALVE  
 KUGELHAHN AUSSENGEW. KONISCH R ISO 7 - ROHR  
 ROBINET FILETAGE R ISO 7 - TUBE  
 VÁLVULA MACHO CÔNICO R ISO 7 - TUBO  
 VÁLVULA ROSCA MACHO CÔNICA R ISO 7 - TUBO

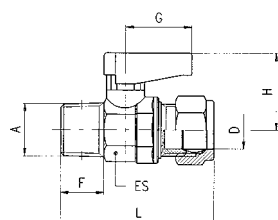

Code	A	D	DN	ES	F	L	G	H	Pack.
06350 00 001	1/8	6	5.5	14-15	7.4	40.5	19	21	10
06350 00 002	1/8	8	5.5	14-15	7.4	41.5	19	21	10
06350 00 003	1/4	6	5.5	14-15	1.1	46	19	21	10
06350 00 004	1/4	8	5.5	14-15	1.1	45	19	21	10
06350 00 005	3/8	10	8	18-19	1.4	50.5	19	22	10
06350 00 006	3/8	12	8	18-19	1.4	51.5	19	22	10
06350 00 007	1/2	14	10	22-23	1.5	59.5	26	30.5	10
06350 00 008	1/2	15	10	22-23	1.5	59.5	26	30.5	10
06350 00 109	3/4	16	14	28-30	16.3	67	50	33	5
06350 00 110	3/4	18	14	28-30	16.3	67	50	33	5

### 6400

**VALVOLA FEMMINA G ISO 228 - FEMMINA G ISO 228**

FEMALE G ISO 228 - FEMALE G ISO 228 VALVE  
 KUGELHAHN INNENGEW. G ISO 228 - INNENGEW. G ISO 228  
 ROBINET TARAUDAGE G ISO 228  
 VÁLVULA HEMBRA G ISO 228 - HEMBRA G ISO 228  
 VÁLVULA ROSCA FÊMEA G ISO 228 - ROSCA FÊMEA G ISO 228

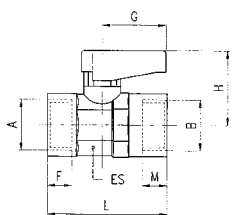

Code	A	B	DN	ES	F	M	L	G	H	Pack.
06400 00 001	1/8	1/8	5.5	14-15	7	7	35	19	21	10
06400 00 002	1/4	1/4	5.5	14-15	8	8	37	19	21	10
06400 00 003	3/8	3/8	8	18-19	9	9	42	19	22	10
06400 00 004	1/2	1/2	10	22-23	10	10	49	26	30.5	10
06400 00 055	3/4	3/4	14	28-30	12	12	58	50	33	5

### 6410

**VALVOLA MASCHIO CILINDRICO GA ISO 228 - FEMMINA G ISO 228**

PARALLEL MALE GA ISO 228 - FEMALE G ISO 228 VALVE  
 KUGELHAHN AUSSENGEW. ZYLINDRISCH GA ISO 228 - INNENGEW. G ISO 228  
 ROBINET FILETAGE GA ISO 228 - TARAUDAGE G ISO 228  
 VÁLVULA MACHO CILÍNDRICO GA ISO 228 - HEMBRA G ISO 228  
 VÁLVULA ROSCA MACHO PARALELA GA ISO 228 - ROSCA FÊMEA G ISO 228

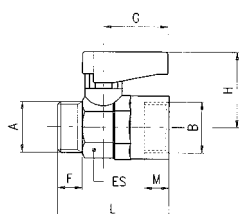

Code	A	B	DN	ES	F	M	L	G	H	Pack.
06410 00 001	1/8	1/8	5.5	14-15	7	7	34	19	21	10
06410 00 002	1/4	1/8	5.5	14-15	8	7	35	19	21	10
06410 00 003	1/4	1/4	5.5	14-15	8	8	35	19	21	10
06410 00 004	3/8	3/8	8	18-19	9	9	39	19	22	10
06410 00 005	1/2	1/2	10	22-23	10	10	45	26	30.5	10
06410 00 066	3/4	3/4	14	28-30	12	12	52	50	33	5

### 6420

**VALVOLA MASCHIO CILINDRICO GA ISO 228 - MASCHIO CILINDRICO GA ISO 228**  
 PARALLEL MALE GA ISO 228 - PARALLEL MALE GA ISO 228 VALVE  
 KUGELHAHN AUSSERGEW. ZYLINDRISCH GA ISO 228 - AUSSERGEW. ZYLINDRISCH GA ISO 228  
 ROBINET FILETAGE GA ISO 228  
 VÁLVULA MACHO CILÍNDRICO GA ISO 228 - MACHO CILÍNDRICO GA ISO 228  
 VÁLVULA ROSCA MACHO PARALELA GA ISO 228 - ROSCA MACHO PARALELA GA ISO 228

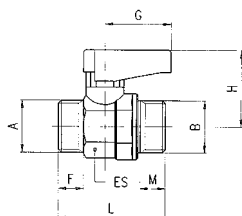

Code	A	B	DN	ES	F	M	L	G	H	Pack.
06420 00 001	1/8	1/8	5.5	14-15	7	7	32	19	21	10
06420 00 002	1/8	1/4	5.5	14-15	7	8	32	19	21	10
06420 00 003	1/4	1/4	5.5	14-15	8	8	33	19	21	10
06420 00 004	3/8	1/4	5.5	14-15	9	8	33	19	21	10
06420 00 005	3/8	3/8	8	18-19	9	9	37	19	22	10
06420 00 006	1/2	3/8	8	18-19	10	9	37	19	22	10
06420 00 007	1/2	1/2	10	22-23	10	10	42	26	30.5	10
06420 00 008	3/4	1/2	10	22-23	12	10	42	50	30.5	10
06420 00 099	3/4	3/4	14	28-30	12	12	49	50	33	5

### 6430

**VALVOLA TUBO - FEMMINA G ISO 228**  
 TUBE - FEMALE G ISO 228 VALVE  
 KUGELHAHN ROHR - INNENGEW. G ISO 228  
 ROBINET TUBE - TARAUDAGE GA ISO 228  
 VÁLVULA TUBO - HEMBRA G ISO 228  
 VÁLVULA TUBO - ROSCA FÊMEA G ISO 228

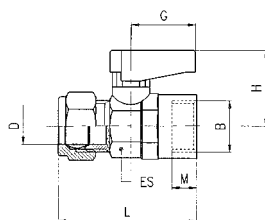

Code	D	B	DN	ES	M	L	G	H	Pack.
06430 00 001	6	1/8	5.5	14-15	7	41	19	21	10
06430 00 002	8	1/8	5.5	14-15	7	43	19	21	10
06430 00 003	8	1/4	5.5	14-15	8	43	19	21	10
06430 00 004	10	3/8	8	18-19	9	48	19	22	10
06430 00 005	12	3/8	8	18-19	9	49	19	22	10
06430 00 006	14	1/2	10	22-23	10	55.5	26	30.5	10
06430 00 007	15	1/2	10	22-23	10	55.5	26	30.5	10
06430 00 098	16	3/4	14	28-30	12	63.5	50	33	5
06430 00 099	18	3/4	14	28-30	12	63.5	50	33	5

### 6440

**VALVOLA MASCHIO CILINDRICO GA ISO 228 - TUBO**  
 PARALLEL MALE GA ISO 228 - TUBE VALVE  
 KUGELHAHN AUSSERGEW. ZYLINDRISCH GA ISO 228 - ROHR  
 ROBINET FILETAGE GA ISO 228 - TUBE  
 VÁLVULA MACHO CILÍNDRICO GA ISO 228 - TUBO  
 VÁLVULA ROSCA MACHO PARALELA GA ISO 228 - TUBO

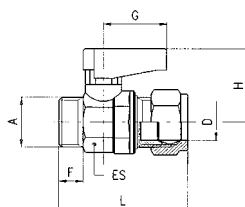

Code	A	D	DN	ES	F	L	G	H	Pack.
06440 00 001	1/8	6	5.5	14-15	7	39	19	21	10
06440 00 002	1/8	8	5.5	14-15	7	40	19	21	10
06440 00 003	1/4	6	5.5	14-15	8	40	19	21	10
06440 00 004	1/4	8	5.5	14-15	8	41	19	21	10
06440 00 005	1/4	10	5.5	14-15	8	44	19	21	10
06440 00 006	3/8	8	5.5	14-15	9	43	19	21	10
06440 00 007	3/8	10	8	18-19	9	46	19	22	10
06440 00 008	3/8	12	8	18-19	9	47	19	22	10
06440 00 009	3/8	14	8	18-19	9	50.5	19	22	10
06440 00 010	3/8	15	8	18-19	9	50.5	19	22	10
06440 00 011	1/2	10	8	18-19	10	49	19	22	10
06440 00 012	1/2	12	8	18-19	10	50	19	22	10
06440 00 013	1/2	14	10	22-23	10	52.5	26	30.5	10
06440 00 014	1/2	15	10	22-23	10	52.5	26	30.5	10
06440 00 015	3/4	14	10	22-23	12	56.5	26	30.5	10
06440 00 016	3/4	15	10	22-23	12	56.5	26	30.5	10
06440 00 197	3/4	16	14	28-30	12	60.5	50	33	5
06440 00 198	3/4	18	14	28-30	12	60.5	50	33	5

Nelle misure 1/4-8, 1/4-10, 3/8-14, 3/8-15 il dado, il bicono e il filetto A sono all'opposto della figura.  
 In the sizes 1/4-8, 1/4-10, 3/8-14, 3/8-15 the nut, the double cone and the thread A are at the opposite side of the picture.

In den Größen 1/4-8, 1/4-10, 3/8-14, 3/8-15 sind die Überwurfmutter mit dem Klemmring und das Gewinde A auf der gegenüberliegenden Seite des Bildes.

Pour les dimensions 1/4-8, 1/4-10, 3/8-14, 3/8-15, le filetage A et le raccord sont inversés par rapport à l'image.

En las medidas 1/4-8, 1/4-10, 3/8-14, 3/8-15 la tuerca, el bicono y la rosca A son opuestos a la figura.  
 Nos tamanhos 1/4-8, 1/4-10, 3/8-14, 3/8-15 a porca, o cone duplo e a rosca A são do lado oposto ao mostrado na foto.

## 6450

### VALVOLA TUBO - TUBO

TUBE - TUBE VALVE  
KUGELHAHN ROHR - ROHR  
ROBINET TUBE - TUBE  
VÁLVULA TUBO - TUBO  
VÁLVULA TUBO - TUBO

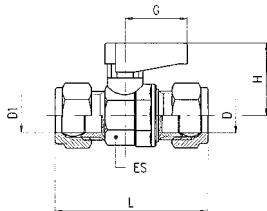

Code	D1	D	DN	ES	L	G	H	Pack.
06450 00 001	6	6	5.5	14-15	46	19	21	10
06450 00 002	6	8	5.5	14-15	48	19	21	10
06450 00 003	8	8	5.5	14-15	48	19	21	10
06450 00 004	10	8	5.5	14-15	51	19	21	10
06450 00 005	10	10	8	18-19	55	19	22	10
06450 00 006	10	12	8	18-19	56	19	22	10
06450 00 007	12	12	8	18-19	57	19	22	10
06450 00 008	14	10	8	18-19	59.5	19	22	10
06450 00 009	14	12	8	18-19	60.5	19	22	10
06450 00 010	15	10	8	18-19	59.5	19	22	10
06450 00 011	15	12	8	18-19	60.5	19	22	10
06450 00 012	14	14	10	22-23	63	26	30.5	10
06450 00 013	15	14	10	22-23	63	26	30.5	10
06450 00 014	15	15	10	22-23	63	26	30.5	10
06450 00 015	16	14	10	22-23	68	26	30.5	10
06450 00 016	16	15	10	22-23	68	26	30.5	10
06450 00 017	18	14	10	22-23	68	26	30.5	10
06450 00 018	18	15	10	22-23	68	26	30.5	10
06450 00 219	18	16	14	28-30	71	50	33	5
06450 00 220	18	18	14	28-30	71	50	33	5

## 6460

**No Gas**

### VALVOLA DADO CAPETTATO - MASCHIO CONICO R ISO 7

MILLED NUT - TAPER MALE R ISO 7 VALVE  
KUGELHAHN RÄNDELMUTTER - AUSSENGEW. KONISCH R ISO 7  
ROBINET ECROU MOLETÉ - FILETAGE R ISO 7  
VÁLVULA TUERCA - MACHO CÓNICO R ISO 7  
VÁLVULA PORCA RECARILHADA - ROSCA MACHO CÓNICA R ISO 7

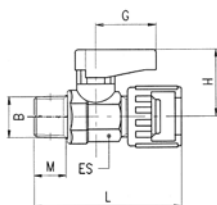

Code	B	DN	ES	M	L	G	H	Pack.
06460 00 001	1/8	5.5	14-15	7.4	44	19	21	10
06460 00 002	1/4	5.5	14-15	11	49.5	19	21	10
06460 00 003	3/8	8	18-19	11.4	50	19	21	10

## 6470

**No Gas**

### VALVOLA DADO CAPETTATO - FEMMINA G ISO 228

MILLED NUT - FEMALE G ISO 228 VALVE  
KUGELHAHN RÄNDELMUTTER - INNENGEW. G ISO 228  
ROBINET ECROU MOLETÉ - TARAUDAGE G ISO 228  
VÁLVULA TUERCA - HEMBRA G ISO 228  
VÁLVULA PORCA RECARILHADA - ROSCA FÊMEA G ISO 228

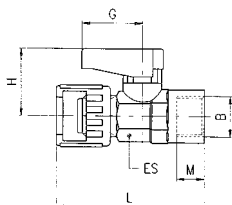

Code	B	DN	ES	M	L	G	H	Pack.
06470 00 001	1/8	5.5	14-15	7	46	19	21	10
06470 00 002	1/4	5.5	14-15	8	46	19	21	10

**6490**

**VALVOLA CON PIEDINI D'ANCORAGGIO FEMMINA-FEMMINA**

FOOT MOUNTED FEMALE-FEMALE VALVE  
 KUGELHAHN MIT INNENGEWINDE UND BEFESTIGUNGSBÜGEL  
 ROBINET - TARAUDAGE, PLAQUE DE FIXATION  
 VÁLVULA CON PIE DE ANCLAJE HEMBRA-HEMBRA  
 VÁLVULA COM PÉS DE FIXAÇÃO ROSCA FÊMEA-FÊMEA

Code	A	B	DN	ES	L	F	M	G	H	H1	P	Pack.
06490 00 002	1/4	1/4	5,5	14-15	43,5	8	8	19	21	31,5	30	10
06490 00 003	3/8	3/8	8	18-19	44	9	9	19	22	38	32	10

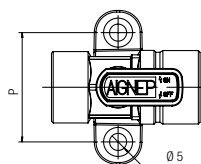
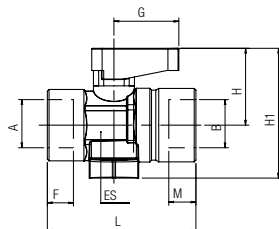

**6500**

**VALVOLA CON PIEDINI D'ANCORAGGIO TUBO-TUBO**

FOOT MOUNTED TUBE-TUBE VALVE  
 KUGELHAHN MIT BEFESTIGUNGSFLANSCH ROHR-ROHR  
 ROBINET TUBE - TUBE, PLAQUE DE FIXATION  
 VÁLVULA CON PIE DE ANCLAJE TUBO-TUBO  
 VÁLVULA COM PÉS DE FIXAÇÃO TUBO-TUBO

Code	D	D1	DN	ES	L	H	H1	G	P	Pack.
06500 00 001	8	8	5,5	14-15	50	21	32	19	30	10

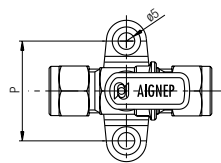
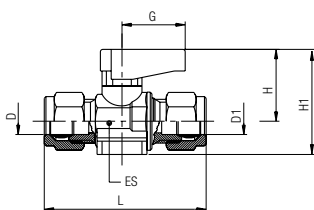

**6540**

**VALVOLA A L MASCHIO CILINDRICO GA ISO 228-MASCHIO CONICO R ISO 7**

ELBOW PARALLEL MALE GA ISO 228-TAPER MALE R ISO 7 VALVE  
 WINKELKUGELHAHN AUSSENGEW. ZYLINDRISCH GA ISO 228 - AUSSENGEW. KONISCH R ISO 7  
 ROBINET EN EQUERRE, FILETAGE R ISO 7 - FILETAGE GA ISO 228  
 VÁLVULA A L MACHO CILÍNDRICO GA ISO 228 - MACHO CÓNICO R ISO 7  
 VÁLVULA EM "L" ROSCA MACHO PARALELA GA ISO 228-ROSCA MACHO CÔNICA R ISO 7

Code	A	B	DN	ES	ES1	L	H	H1	G	Pack.
06540 00 001	1/4	1/4	5,5	14-15	17	48	21	17	19	10

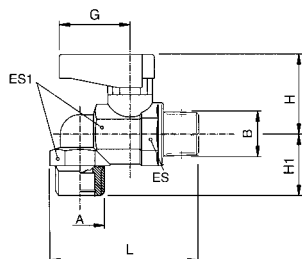

## 6560

**No Gas**

### VALVOLA CON ATTACCHI TUBO AUTOMATICI

PUSH-IN CONNECTIONS VALVE

KUGELHAHN MIT STECKANSCHLUSS ROHR - ROHR

ROBINET, RACCORD INSTANTANÉ

VÁLVULA PARA TUBO AUTOMÁTICO

VÁLVULA COM ENGATE RÁPIDO PARA TUBO

Code	Tube	Tube	DN	ES	L	G	H	Pack.
06560 00 001	4	4	3	14-15	44	19	21	10
06560 00 002	6	6	5	14-15	48	19	21	10
06560 00 003	8	8	5.5	14-15	48	19	21	10
06560 00 075	10	10	8	18-19	58.5	19	22	10
06560 00 076	12	12	10	22-23	66	26	30.5	10

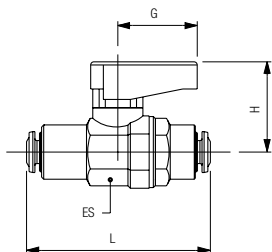

## 6570

**No Gas**

### VALVOLA MASCHIO CONICO R ISO 7 - ATTACCO TUBO AUTOMATICO

TAPER MALE R ISO 7 - PUSH-FIT CONNECTIONS VALVE

KUGELHAHN AUSSENGEW. KONISCH R ISO 7 - ROHR STECKANSCHLUSS

ROBINET TARAUDAGE R ISO 7 - RACCORD INSTANTANÉ

VÁLVULA A ESFERA MACHO - TUBO AUTOMÁTICO

VÁLVULA ROSCA MACHO CÓNICA R ISO 7 - ENGATE RÁPIDO PARA TUBO

Code	A	Tube	DN	F	ES	L	C	H	Pack.
06570 00 001	1/8	4	3	8.5	14-15	35	19	21	10
06570 00 002	1/8	6	5	8.5	14-15	40	19	21	10
06570 00 004	1/8	8	5.5	8.5	14-15	41.5	19	21	10
06570 00 003	1/4	6	5	12.5	14-15	38.5	19	21	10
06570 00 005	1/4	8	5.5	12.5	14-15	45.5	19	22	10

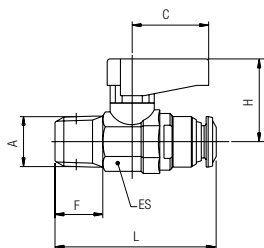

## 6600

**No Gas**

### VALVOLA CON FORO DI SFIATO FEMMINA G ISO 228

EXHAUST HOLE FEMALE G ISO 228 - FEMALE G ISO 228 VALVE

KUGELHAHN MIT ENTLÜFTUNGSBOHRUNG INNENGEW. G ISO 228

ROBINET AVEC PURGE - TARAUDAGE G ISO 228

VÁLVULA HEMBRA ISO 228 CON ESCAPE ATMÓSFERA

VÁLVULA COM FURO DE ESCAPE E ROSCA FÊMEA G ISO 228

Code	A	B	DN	ES	F	M	L	G	H	S	Pack.
06600 00 001	1/8	1/8	5.5	14-15	7	7	35	19	21	2.5	10
06600 00 002	1/4	1/4	5.5	14-15	8	8	37	19	21	2.5	10
06600 00 003	3/8	3/8	8	18-19	9	9	42	19	22	3	10

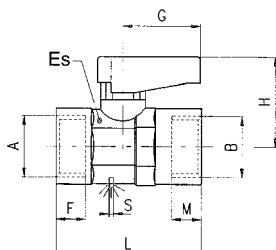

OPEN

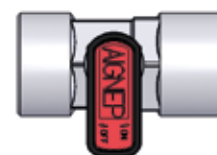

CLOSE



## 86300

### VALVOLA FEMMINA NPTF - FEMMINA NPTF

NPTF FEMALE - NPTF FEMALE VALVE

KUGELHAHN INNENGEW. NPTF - INNENGEW. NPTF

ROBINET - TARAUDAGE NPTF

VÁLVULA HEMBRA NPTF - HEMBRA NPTF

VÁLVULA ROSCA FÊMEA NPTF - ROSCA FÊMEA NPTF

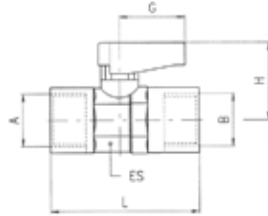

Code	A	B	DN	ES	L	G	H	Pack.
86300 00 001	1/8	1/8	5.5	14-15	37,5	19	21	10
86300 00 002	1/4	1/4	5.5	14-15	46	19	21	10
86300 00 003	3/8	3/8	8	18-19	48,5	19	22	10
86300 00 004	1/2	1/2	10	22-23	62	26	30,5	10

## 86310

### VALVOLA MASCHIO NPTF - FEMMINA NPTF

TAPER NPTF MALE - NPTF FEMALE VALVE

KUGELHAHN AUSSENGEW. NPTF KONISCH - INNENGEW. NPTF

ROBINET FILETAGE NPTF - TARAUDAGE NPTF

VÁLVULA MACHO NPTF - HEMBRA NPTF

VÁLVULA ROSCA MACHO NPTF - ROSCA FÊMEA NPTF



Code	A	B	DN	ES	F	L	G	H	Pack.
86310 00 001	1/8	1/8	5.5	14-15	8,5	37,5	19	21	10
86310 00 002	1/4	1/4	5.5	14-15	13	46	19	21	10
86310 00 003	3/8	3/8	8	18-19	13	48,5	19	22	10
86310 00 004	1/2	1/2	10	22-23	17	62	26	30,5	10

**SERIE GHINOX**

MINIVALVOLE A SFERA IN ACCIAIO INOX AISI 316 L  
 MINIBALLVALVE IN STAINLESS STEEL AISI 316 L  
 KUGELHÄHNE AISI 316 L  
 MINI ROBINET A BOISSEAU SPERIQUE EN ACIER INOXYDABLE AISI 316L  
 MINI VÁLVULAS A ESFERA EN ACERO INOX AISI 316L  
 MINI VÁLVULAS DE ESFERA EM AÇO-INOX AISI 316L



**CARATTERISTICHE TECNICHE**

TECHNICAL CHARACTERISTICS  
 TECHNISCHE ANGABEN  
 CARACTÉRISTIQUES TECHNIQUES  
 CARACTERÍSTICAS TÉCNICAS  
 CARACTERÍSTICAS TÉCNICAS



**Norma di Riferimento**

Reference standard

Entspricht der Norm

Norme de référence

Normativa de referencia

Norma de referência

1907/2006



2011/65/CE



PED

2014/68/UE

SILICON

FREE

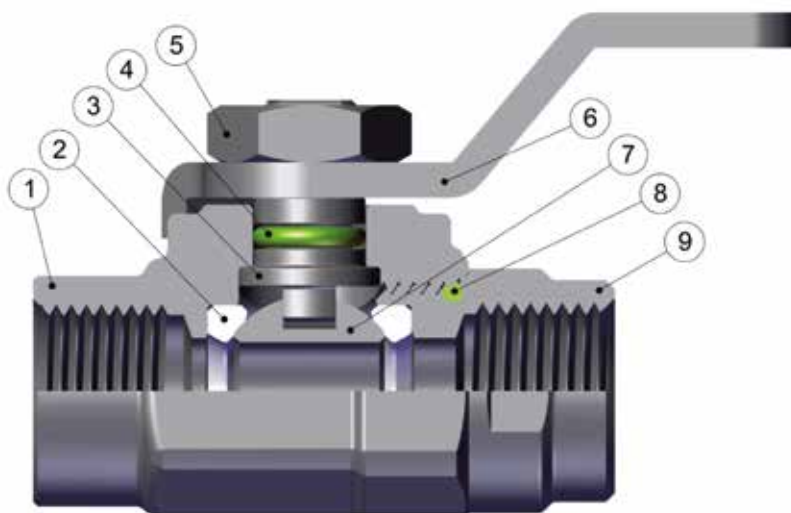

**Materiali e Componenti**

IT

- 1 Corpo in acciaio inox AISI 316L
- 2 Guarnizione sede sfera in PTFE
- 3 Albero in acciaio inox AISI316L
- 4 Guarnizione O-RING in FKM
- 5 Dado esagonale in acciaio inox AISI316L
- 6 Leva di comando in acciaio inox AISI316L
- 7 Sfera in acciaio inox AISI316L
- 8 Guarnizione O-RING in FKM
- 9 Raccordo in acciaio inox AISI316L

**Component Parts and Materials**

GB

- 1 Stainless steel AISI 316L Body
- 2 PTFE Seats
- 3 Stainless steel AISI316L Spindle 4 FKM Seal O-RING
- 4 FKM Seal O-RING
- 5 Stainless steel AISI316L Hex Nut 6 Stainless steel AISI316L Spindle
- 6 Stainless steel AISI316L Spindle
- 7 Stainless steel AISI316L Ball 8 FKM Seal O-RING
- 8 FKM Seal O-RING
- 9 Stainless steel AISI316L Fitting

**Komponenten und Materialien**

DE

- 1 Körper inox AISI 316L
- 2 Kugelsitzdichtung PTFE
- 3 Spindel inox AISI316L
- 4 O-RING FKM
- 5 Mutter inox AISI316L
- 6 Handgriff inox AISI316L
- 7 Kugel inox AISI316L
- 8 O-RING FKM
- 9 Gewindeinsatz inox AISI316L

**Matériaux et Composants**

FR

- 1 Corps: acier inoxydable AISI 316L
- 2 Joint bille sphérique PTFE
- 3 Tige: acier inoxydable AISI316L
- 4 Joint tige: FKM
- 5 Ecrou: acier inoxydable AISI316L
- 6 Poignée: acier inoxydable AISI316L
- 7 Bille: acier inoxydable AISI316L
- 8 Joint tige: FKM
- 9 Corps: acier inoxydable AISI316L

**Materiales y Componentes**

ES

- 1 Cuerpo en acero inox AISI 316L
- 2 Junta sede esfera en PTFE
- 3 Eje en acero inox AISI316L
- 4 Junta tórica en FKM
- 5 Tuerca hexagonal en acero inox AISI316L
- 6 Maneta de mando en acero inox AISI316L
- 7 Esfera en acero inox AISI316L
- 8 Junta tórica en FKM
- 9 Racor en acero inox AISI316L

**Materiais e Componentes**

PT

- 1 Corpo em aço-inox AISI 316L
- 2 Vedação da sede da esfera em PTFE
- 3 Eixo em aço-inox AISI316L
- 4 O-ring de Vedação em FKM
- 5 Porca Sextavada em aço-inox AISI316L
- 6 Haste de comando em aço-inox AISI316L
- 7 Esfera em aço-inox AISI316L
- 8 O-ring de Vedação em FKM
- 9 Conexão em aço-inox AISI316L



**Pressioni**

Pressures

Druckbereich

Pressions

Presiones

Pressões

- 0.99 bar (-0.099 MPa)

40 bar (4 MPa)



**Filettatura**

**Threads**

Gas conforme ISO 7.1, BS 21, DIN 2999

Gas in conformity with ISO7.1, BS 21, DIN 2999.

**Gewindearten**

**Filetages**

Gewinde nach Norm ISO 7.1, BS 21, DIN 2999

Filetage conforme: ISO7.1, BS 21, DIN 2999.

**Roscas**

**Roscas**

Gas conforme ISO 7.1, BS 21, DIN 2999

Gas conforme ISO 7.1, BS 21, DIN 2999





**Fluidi compatibili**

Aria compressa / Vuoto / Acqua / Oli

Fluidi per Industria alimentare e chimica compatibili con i componenti.

**Fluids**

Compressed air / Vacuum / Water / Oils

Fluid for food and chemical industry compatible with components.

**Geeignete Medien**

Druckluft / Vakuum / Wasser / Oel

Medien für die Lebensmittel- und chemische Industrie, die beständig mit den der Verschraubungen sind.

**Fluides compatibles**

Air comprimé / Vide / Eau / Huile

Fluides alimentaires et chimiques compatibles avec les matériaux constitutants.

**Fluidos compatibles**

Aire comprimido / Vacío / Agua / Aceite

Fluidos para industria alimentaria y química compatibles con los componentes.

**Fluidos compatíveis**

Ar comprimido / Vácuo / Água / Óleos

Fluidos para Indústria alimentícia e química compatíveis com os componentes.



**Temperatura minima**

Minimum temperature

Temperatur minimum

Température minimale

Temperatura mínima

Temperatura mínima

**- 15 °C**

**Temperatura massima in continuo**

Maximum temperature in continuous

Temperatur maximum kontinuierlich

Température maximale en continu

Temperatura máxima en continuo

Temperatura máxima em contínuo

**+ 150 °C**

**Temperatura massima per breve durata**

Maximum temperature for short term

Temperatur maximum für kurzfristig

Pic de température maximale

Temperatura máxima de corta duración

Temperatura máxima em curta duração

**+ 180 °C**

**66300**

**VALVOLA FEMMINA RP ISO 7 - FEMMINA RP ISO 7**

FEMALE RP ISO 7 - FEMALE RP ISO 7 VALVE

KUGELHAHN INNENGEW. RP ISO 7 - INNENGEW. RP ISO 7

ROBINET INOX, TARAUDAGE RP ISO 7

VÁLVULA HEMBRA RP ISO 7 - HEMBRA RP ISO 7

VÁLVULA FÊMEA RP ISO 7 - FÊMEA RP ISO 7

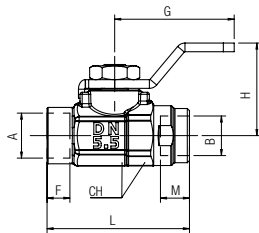

Code	A	B	DN	CH	F	M	L	G	H	Pack.
66300 00 001	1/8	1/8	5,5	14-15	8,5	8,5	33	28	21,5	2
66300 00 002	1/4	1/4	5,5	16-17	12,5	12,5	43	28	21,5	2

**66310**

**VALVOLA MASCHIO CONICO R ISO 7 - FEMMINA RP ISO 7**

TAPER MALE R ISO 7 - FEMALE RP ISO 7 VALVE

KUGELHAHN AUSSENGEW. KONISCH R ISO 7 - INNENGEW. RP ISO 7

ROBINET INOX, FILETAGE R ISO 7 - TARAUDAGE RP ISO 7

VÁLVULA MACHO CÓNICO R ISO 7 - HEMBRA RP ISO 7

VÁLVULA MACHO CÔNICA R ISO 7 - FÊMEA RP ISO 7

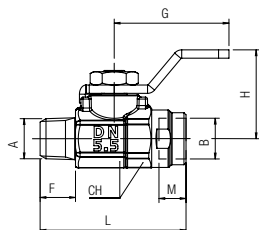

Code	A	B	DN	CH	F	M	L	G	H	Pack.
66310 00 001	1/8	1/8	5,5	14-15	8,5	8,5	35	28	21,5	2
66310 00 002	1/4	1/4	5,5	16-17	12,5	12,5	44,5	28	21,5	2

**MINIVALVOLA A SFERA A 2-3 VIE**

2-3 WAYS MINIBALLVALVE

DREIWEGKUGELHAHN

MINI ROBINET A BOISSEAU SHERIQUE 2-3 VOIES

MINIVÁLVULA DE ESFERA 2-3 VÍAS

MINI-VÁLVULA DE ESFERA DE 2-3 VIAS



**CARATTERISTICHE TECNICHE**

TECHNICAL CHARACTERISTICS  
TECHNISCHE ANGABEN  
CARACTÉRISTIQUES TECHNIQUES  
CARACTERÍSTICAS TÉCNICAS  
CARACTERÍSTICAS TÉCNICAS



**Norma di Riferimento**

Reference standard  
Entspricht der Norm  
Norme de référence  
Normativa de referencia  
Norma de referência

1907/2006

REACH

2011/65/CE

RoHS

PED  
2014/68/UE

SILICON  
FREE

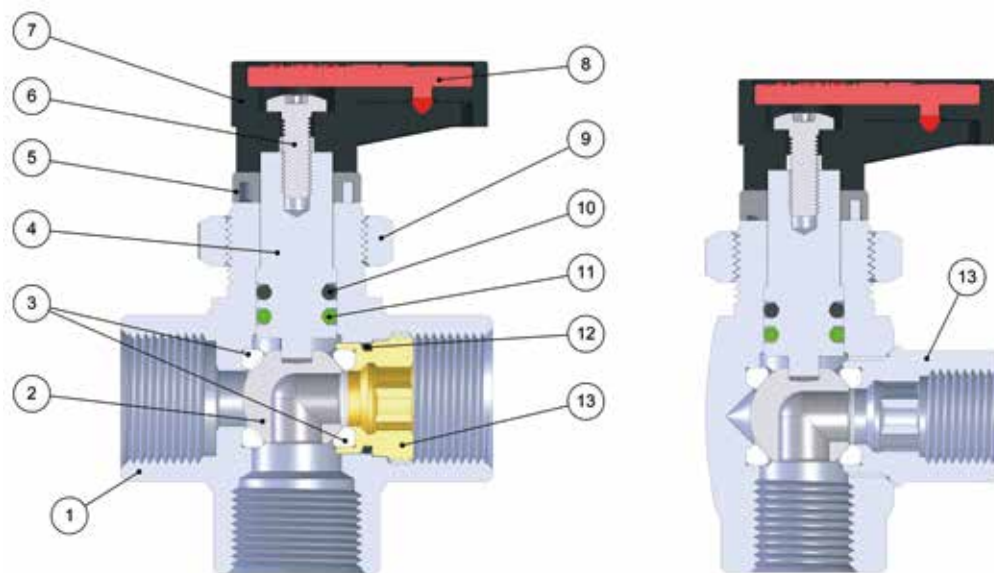

**FKM A RICHIESTA**  
IF REQUESTED FKM  
FKM AUF ANFRAGE  
FKM SUR DEMANDE  
FKM BAJO PEDIDO  
FKM SOB ENCOMENDA

**Materiali e Componenti**

IT

- 1 Corpo in Ottone cromato
- 2 Sfera in Ottone cromato
- 3 Guarnizione sede sfera in PTFE
- 4 Albero in Ottone cromato
- 5 Fermo Maniglia
- 6 Vite in acciaio
- 7 Maniglietta in PA66 Caricato vetro
- 8 Piastrina in Resina Acetalica
- 9 Ghiera per passaparete
- 10 Guarnizione O-RING in NBR
- 11 Guarnizione O-RING in FKM
- 12 Guarnizione O-RING in NBR
- 13 Ghiera o raccordo in Ottone

**Component Parts and Materials**

GB

- 1 Chrome Nickel-plated Brass Body
- 2 Chrome Nickel-plated Brass Ball
- 3 PTFE Seat
- 4 Chrome Nickel-plated Brass Spindle
- 5 Stop Handle
- 6 Steel Screw
- 7 PA66 Glass reinforced Handle
- 8 Acetalic resin Plate
- 9 Bulkhead nut
- 10 NBR Seal O-RING
- 11 FKM Seal O-RING
- 12 NBR Seal O-RING
- 13 Brass Fitting

**Komponenten und Materialien**

DE

- 1 Körper Messing verchromt
- 2 Kugel Messing verchromt
- 3 Kugelsitzdichtung PTFE
- 4 Spindel Messing verchromt
- 5 Anschlag
- 6 Schraube Stahl
- 7 Handgriff PA66 Glasfaser verstärkt
- 8 Griffplatte Acetal
- 9 Mutter Messing Vernickelt
- 10 O-RING in NBR
- 11 O-RING in FKM
- 12 O-RING in NBR
- 13 Körper Messing verchromt

**Matériaux et Composants**

FR

- 1 Corps: laiton chromé
- 2 Bille: laiton chromé
- 3 Joint bille sphérique: PTFE
- 4 Tige: laiton chromé
- 5 Butée
- 6 Vis: acier
- 7 Poignée: PA66 chargé en fibre de verre
- 8 Plaquette de poignée: résine acétal
- 9 Ecrou: Laiton nickélé
- 10 Joint torique NBR
- 11 Joint torique FKM
- 12 Joint torique NBR
- 13 Corps: laiton chromé

**Materiales y Componentes**

ES

- 1 Cuerpo en latón cromado
- 2 Esfera en latón cromado
- 3 Junta de asiento esfera en PTFE
- 4 Eje en latón cromado
- 5 Base Maneta
- 6 Tornillo en acero
- 7 Maneta en PA66 fibra de vidrio
- 8 Plaqueta en resina acetalica
- 9 Tuerca para pasatabiques
- 10 Junta O-RING en NBR
- 11 Junta O-RING en FKM
- 12 Junta O-RING en NBR
- 13 Tuerca o racor en latón

**Materiais e Componentes**

PT

- 1 Corpo em latão cromado
- 2 Esfera em latão cromado
- 3 Vedação sede da esfera em PTFE
- 4 Árvore em latão cromado
- 5 Fixador de manopla
- 6 Parafuso em aço
- 7 Manopla em PA66
- 8 Plaqueta em resina acetalica
- 9 Porca de fixação passa-muro
- 10 Vedação O-RING in NBR
- 11 Vedação O-RING em FKM
- 12 Vedação O-RING em NBR
- 13 Proca e conexão em Latão



**Pressioni**

Pressures

Druckbereich

Pressions

Presiones

Pressões

**-0.99** (-0.099 MPa)

**20 bar** (2 MPa)



**Temperature**

Temperatures

Temperatur

Températures

Temperaturas

Temperaturas

**- 20 °C**

**+ 80 °C**

**FKM**

**- 15 °C**

**+ 130 °C**



**Fluidi compatibili**

Aria compressa / Acqua / Oli

1ª e 2ª famiglia di gas a media pressione.

3ª famiglia di gas a bassa pressione.

**Fluids**

Compressed air / Water / Oils

1st and 2nd family gases at medium pressure.

3rd family gases at low pressure.

**Geeignete Medien**

Druckluft / Wasser / Oel

1. und 2. Familie von Gasen für Mitteldruck.

3. Familie von Gasen für Niederdruck.

**Fluides compatibles**

Air comprimé / Eau / Huile

Famille 1 et 2 des gaz à moyenne pression.

Famille 3 des gaz à base pression.

**Fluidos compatibles**

Aire comprimido / Água / Aceite

1ª y 2ª familia de gases a media presión.

3ª familia de gas a baja presión.

**Fluidos compatíveis**

Ar comprimido / Água / Óleos

1ª e 2ª família de gás a média pressão.

3ª família de gás a baixa pressão.



**Filettatura**

**IT**

**Threads**

**GB**

**Gewindearten**

**DE**

Gas conforme ISO 7.1, BS 21, DIN 2999.  
Gas cilindrica conforme ISO 228 Classe A.

Gas in conformity with ISO 7.1, BS 21, DIN 2999.  
Parallel gas in conformity with ISO 228 Class A.

Gewinde nach Norm ISO 7.1, BS 21, DIN 2999.  
Zylindrisches Gewinde nach Norm ISO 228 Classe A.

**Filetages**

**FR**

**Roscas**

**ES**

**Roscas**

**PT**

Filetage conforme: ISO 7.1, BS 21, DIN 2999.  
Filetage cylindrique conforme: ISO 228 Class A.

Gas conforme ISO 7.1, BS 21, DIN 2999.  
Gas cilindrica conforme ISO 228 Clase A.

Gas conforme ISO 7.1, BS 21, DIN 2999.  
Gas paralela conforme ISO 228 Classe A.

**6700**

**No Gas**

**VALVOLA TRE VIE A L FEMMINA G ISO 228**

3 WAYS VALVE "L" FEMALE G ISO 228

DREIWEGEKUGELHAHN INNENGEW. G ISO 228

ROBINET A VOIES TARAUDAGE G ISO 228

VÁLVULA A 3 VÍAS HEMBRA G ISO 228

VÁLVULA DE TRÊS VIAS ROSCA FÊMEA G ISO 228

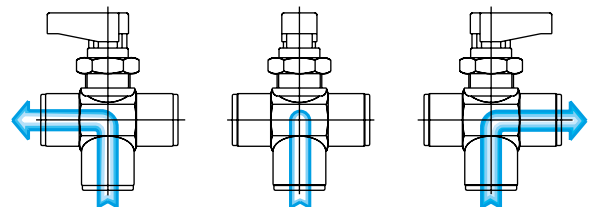
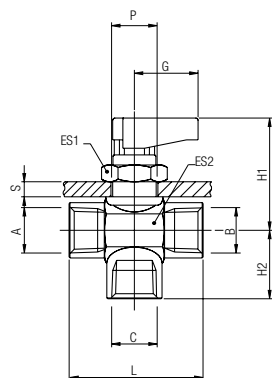

Code	A	B	C	DN	ES1	ES2	L	G	H1	H2	S max	P	Pack.
06700 00 001	1/8	1/8	1/8	5	17	17	35	19	33.5	15.5	4.5	14.5	10
06700 00 002	1/4	1/4	1/4	5	17	17	37	19	33.5	17.5	4.5	14.5	10
06700 00 003	3/8	3/8	3/8	7	17	21	42	19	35	19.5	4.5	14.5	10

**6710**

**No Gas**

**VALVOLA TRE VIE A T FEMMINA G ISO 228**

3 WAYS VALVE "T" FEMALE G ISO 228

DREIWEGEKUGELHAHN INNENGEW. G ISO 228

ROBINET A VOIES TARAUDAGE G ISO 228

VÁLVULA A 3 VÍAS HEMBRA G ISO 228

VÁLVULA DE TRÊS VIAS ROSCA FÊMEA G ISO 228

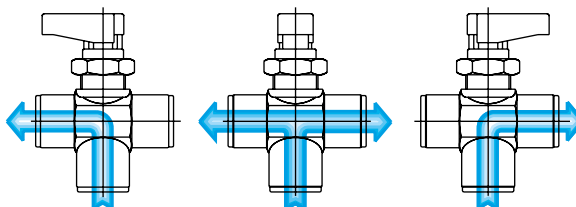
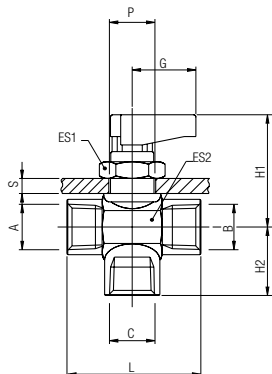

Code	A	B	C	DN	ES1	ES2	L	G	H1	H2	S max	P	Pack.
06710 00 001	1/8	1/8	1/8	5	17	17	35	19	33.5	15.5	4.5	14.5	10
06710 00 002	1/4	1/4	1/4	5	17	17	37	19	33.5	17.5	4.5	14.5	10
06710 00 003	3/8	3/8	3/8	7	17	21	42	19	35	19.5	4.5	14.5	10

**6720**

**No Gas**

**VALVOLA A L FEMMINA G ISO 228**

VALVE "L" FEMALE G ISO 228

WINKELKUGELHAHN INNENGEW. G ISO 228

ROBINET EQUERRE, FILETAGE G ISO 228

VÁLVULA A L HEMBRA G ISO 228

VÁLVULA EM "L" ROSCA FÊMEA G ISO 228

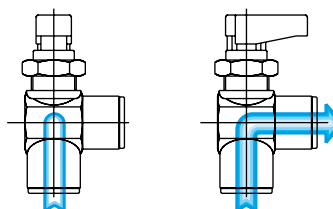
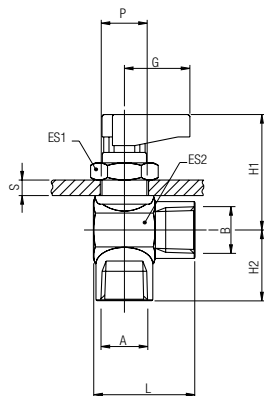

Code	A	B	DN	ES1	ES2	L	G	H1	H2	S max	P	Pack.
06720 00 001	1/8	1/8	5	17	17	28.5	19	33.5	15.5	4.5	14.5	10
06720 00 002	1/4	1/4	5	17	17	28.5	19	33.5	17.5	4.5	14.5	10
06720 00 003	3/8	3/8	7	17	21	31	19	35	19.5	4.5	14.5	10

**ACCESSORI**

ACCESSORIES  
ZUBEHÖR  
ACCESSOIRES  
ACCESORIOS  
ACESÓRIOS

**6900**

**MANIGLIA CORTA**

SHORT HANDLE  
HANDGRIFF KURZ  
POIGNÉE COURT  
MANETA CORTA  
MANOPLA CURTA

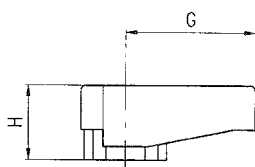

Code	Type	G	H	Pack.
<b>06900 A0 30 00 00</b>	<b>A</b>	19	11	20
<b>06900 B0 30 00 00</b>	<b>B</b>	26	15	20

**A** = Per valvole da 1/8 - 1/4 - 3/8.  
For valves of 1/8 - 1/4 - 3/8.  
Für Kugelhähne mit 1/8 - 1/4 - 3/8.  
Pour vannes 1/8 - 1/4 - 3/8.  
Para válvulas de 1/8 - 1/4 - 3/8.  
Para válvulas de 1/8 - 1/4 - 3/8.

**B** = Per valvole da 1/2 - 3/4.  
For valves of 1/2 - 3/4.  
Für Kugelhähne mit 1/2 - 3/4.  
Pour vannes of 1/2 - 3/4.  
Para válvulas de 1/2 - 3/4.  
Para válvulas de 1/2 - 3/4.

Maniglia CORTA standard per valvola da 1/8-1/4-3/8-1/2.  
Standard SHORT Handle for Valve 1/8-1/4-3/8-1/2.  
Handgriff KURZ Standard für 1/8-1/4-3/8-1/2.  
Poignée COURTE en standard pour 1/8-1/4-3/8-1/2.  
Maneta CORTA estándar para válvula de 1/8-1/4-3/8-1/2.  
Manopla CURTA standard para válvula de 1/8-1/4-3/8-1/2.

**6910**

**MANIGLIA LUNGA**

LONG HANDLE  
HANDGRIFF LANG  
POIGNÉE RALLONGÉE  
MANETA LARGA  
MANOPLA LONGA

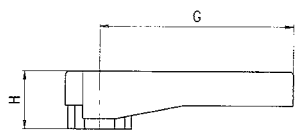

Code	Type	G	H	Pack.
<b>06910 A0 30 00 00</b>	<b>A</b>	35	11	20
<b>06910 B0 30 00 00</b>	<b>B</b>	50	15	20

**A** = Per valvole da 1/8 - 1/4 - 3/8.  
For valves of 1/8 - 1/4 - 3/8.  
Für Kugelhähne mit 1/8 - 1/4 - 3/8.  
Pour vannes 1/8 - 1/4 - 3/8.  
Para válvulas de 1/8 - 1/4 - 3/8.

**B** = Per valvole da 1/2 - 3/4.  
For valves of 1/2 - 3/4.  
Für Kugelhähne mit 1/2 - 3/4.  
Pour vannes of 1/2 - 3/4.  
Para válvulas de 1/2 - 3/4.

Maniglia LUNGA standard per valvola da 3/4.  
standard LONG Handle for Valve 3/4.  
Handgriff LANG Standard für 3/4.  
Poignée RALLONGÉE en standard pour 3/4.  
Maneta LARGA estándar para válvula de 3/4.  
Manopla LONGA standard para válvula de 3/4.

**6915**

**PROLUNGA ALBERO DI COMANDO (CON MANIGLIA LUNGA, VITE)**

SPINDLE EXTENSION (WITH LONG HANDLE, SCREW)  
VERLÄNGERTE SCHALTWELLE (MIT LANGEM GRIFF UND SCHRAUBE)  
EXTENSION AVEC POIGNÉE LONGUE ET VIS  
PROLONGACIÓN EJE DE MANDO (CON MANETA LARGA, TORNILLO Y PLAQUETA)  
PROLONGAMENTO DE EIXODE COMANDO (COM MANOPLA LONGA, PAREFUSOS)

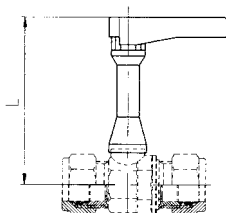

Code	Type	Valve size	L	Pack.
<b>06915 00 001</b>	<b>A</b>	1/8	58	10
		1/4	58	
		3/8	59	
<b>06915 00 002</b>	<b>B</b>	1/2	68	10
		3/4	70	

## 6920

**PIASTRINA COLORATA**  
 COLOURED PLATE  
 HANDGRIFF FARBEN  
 PLAQUETTE DE COULEURS  
 PLAQUETA COLOREADA  
 PLAQUETA COLORIDA



Code	Type	Color	Pack.
06920 A0 30 00 RO	A	Red	100
06920 B0 30 00 RO	B	Red	100
06920 A0 30 00 GI	A	Yellow	100
06920 B0 30 00 GI	B	Yellow	100
06920 A0 30 00 BL	A	Blue	100
06920 B0 30 00 BL	B	Blue	100
06920 A0 30 00 VE	A	Green	100
06920 B0 30 00 VE	B	Green	100
06920 A0 30 00 BN	A	White	100
06920 B0 30 00 BN	B	White	100

## 6680

**DADO**  
 NUT  
 ÜBERWURFMUTTER  
 ECROU  
 TUERCA  
 PORCA

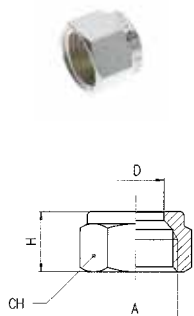

Code	D	A	H	CH	Pack.
06680 00 01 BS CT	6	1/8	11	12	100
06680 00 01 BJ CT	8	1/4	12	15	100
06680 00 01 CG CT	10	3/8	13	19	100
06680 00 01 CL CT	12	3/8	14	19	100
06680 00 01 DB CT	14	1/2	15	24	100
06680 00 01 CP CT	15	1/2	15	24	100
06680 00 01 CS CT	16	3/4	17	30	100
06680 00 01 CX CT	18	3/4	17	30	100

## 10740

**OGIVA OTTONE**  
 BRASS OLIVE  
 KLEMMRING MESSING  
 BAGUE LAITON  
 BICONO LATÓN  
 BUCHA DE LATÃO

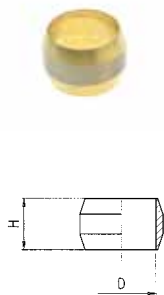

Code	D	H	Pack.
10740 00 02 X4 00	6	6.5	50
10740 00 02 X7 00	8	6.5	50
10740 00 02 X9 00	10	7.5	50
10740 00 02 Y1 00	12	8	50
10740 00 02 Y4 00	15	9	20
10740 00 02 Y7 00	18	10	20

## 10741

**OGIVA OTTONE**  
 BRASS OLIVE  
 KLEMMRING MESSING  
 BAGUE LAITON  
 BICONO LATÓN  
 BUCHA DE LATÃO

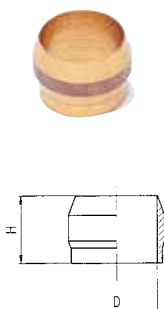

Code	D	H	Pack.
10741 00 01 Y3 00	14	12	50
10741 00 01 Y5 00	16	13.5	50

## 10760

**OGIVA PTFE**  
 PTFE OLIVE  
 KLEMMRING PTFE  
 BAGUE PTFE  
 BICONO PTFE  
 BUCHA DE PTFE

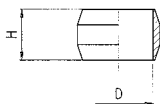

Code	D	H	Pack.
10760 00 28 X4 00	6	6.5	50
10760 00 28 X7 00	8	6.5	50
10760 00 28 X9 00	10	7.5	50
10760 00 28 Y1 00	12	8	50
10760 00 28 Y4 00	15	9	50
10760 00 28 Y7 00	18	10	50

## 10761

**OGIVA PTFE**  
 PTFE OLIVE  
 KLEMMRING PTFE  
 BAGUE PTFE  
 BICONO PTFE  
 BUCHA DE PTFE

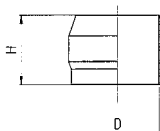

Code	D	H	Pack.
10761 00 28 Y3 00	14	12	50
10761 00 28 Y5 00	16	13.5	50

**MINIVALVOLE A SFERA**

MINIBALL VALVES  
 MINI-KUGELHÄHNE  
 ROBINET MINI  
 MINI VÁLVULAS A ESFERA  
 MINI VÁLVULAS DE ESFERA



**Norma di Riferimento**

Reference standard

Entspricht der Norm

Norme de référence

Normativa de referencia

Norma de referência

1907/2006

REACH ✓

2011/65/CE

RoHS ✓

PED  
2014/68/UE

SILICON  
FREE

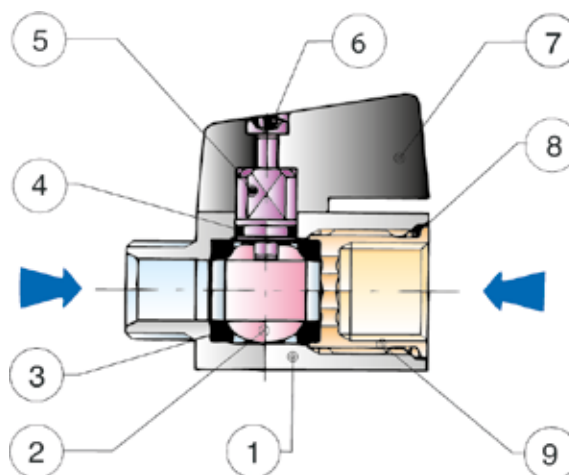

**Materiali e Componenti**

IT

- 1 Corpo in Ottone nichelato
- 2 Sfera in Ottone nichelato
- 3 Guarnizione sede sfera in PTFE
- 4 Guarnizione O-RING in NBR
- 5 Albero in Ottone nichelato
- 6 Vite in acciaio
- 7 Maniglia in PA66 Caricato vetro - 3/4 alluminio
- 8 Guarnizione O-RING in NBR
- 9 Ghiera o raccordo in Ottone nichelato

**Component Parts and Materials**

GB

- 1 Nickel-plated Brass Body
- 2 Nickel-plated Brass Ball
- 3 PTFE Seats
- 4 NBR Seal O-RING
- 5 Nickel-plated Brass Spindle
- 6 Steel Screw
- 7 PA66 Glass reinforced Handle -3/4 Aluminium
- 8 NBR Seal O-RING
- 9 Nickel-plated Brass Fitting

**Komponenten und Materialien**

DE

- 1 Körper Messing vernickelt
- 2 Kugel Messing vernickelt
- 3 Kugelsitzdichtung PTFE
- 4 O-Ring NBR
- 5 Spindel Messing vernickelt
- 6 Schraube Stahl
- 7 Handgriff PA66 Glasfaser verstärkt - 3/4 Aluminium
- 8 O-Ring NBR
- 9 Gewindeinsatz Messing vernickelt

**Matériaux et Composants**

FR

- 1 Corps: laiton nickelé
- 2 Bille: laiton nickelé
- 3 Joint bille sphérique: PTFE
- 4 Joint tige: NBR
- 5 Tige: laiton nickelé
- 6 Vis: acier
- 7 Poignée: PA66 chargé en fibre de verre - 3/4 Aluminium
- 8 Joint tige: NBR
- 9 Ecrou de blocage: laiton nickelé

**Materiales y Componentes**

ES

- 1 Cuerpo en latón niquelado
- 2 Esfera en latón niquelado
- 3 Junta sede esfera en PTFE
- 4 Junta tórica O-RING en NBR
- 5 Eje en latón niquelado
- 6 Tornillo en acero
- 7 Maneta en PA66 con fibra de vidrio - 3/4 aluminio
- 8 Junta tórica O-RING en NBR
- 9 Racor en latón niquelado

**Materiais e Componentes**

PT

- 1 Corpo em Latão Niquelado
- 2 Esfera em Latão Niquelado
- 3 Vedação da sede da esfera em PTFE
- 4 Vedação O-RING em NBR
- 5 Eixo em Latão Niquelado
- 6 Parafuso em aço
- 7 Manopla em PA66 com Fibra de Vidro - 3/4 Alumínio
- 8 Vedação O-RING em NBR
- 9 Conexão em Latão Niquelado



**Pressioni**

Pressures

Druckbereich

Pressions

Presiones

Pressões

**-0.99** (-0.099 MPa)

**10 bar** (1 MPa)



**Temperature**

Temperatures

Temperatur

Températures

Temperaturas

Temperaturas

**- 15 °C**  
**+ 110 °C**

Con Acqua  
 With Water  
 Mit Wasser  
 Avec de l'Eau  
 Con Agua  
 Com Água

**0 °C**  
**+ 90 °C**



**Fluidi compatibili**

Aria compressa / Acqua / Oli / Vuoto

Fluids

Compressed air / Water / Oils / Vacuum

Geeignete Medien

Druckluft / Wasser / Verschiedene Oele / Vakuum

Fluides compatibles

Air comprimé / Eau / Huiles / Vide

Fluidos compatibles

Aire comprimido / Agua / Aceite / Vacío

Fluidos compatíveis

Ar comprimido / Água / Óleos / Vazio



**6065**

**No Gas**

**VALVOLA A SFERA MINI FEMMINA G ISO 228 - FEMMINA G ISO 228**

MINI BALL VALVE FEMALE G ISO 228 - FEMALE G ISO 228  
 MINI-KUGELHAHN INNENGEW. G ISO 228 - INNENGEW. G ISO 228  
 MINI ROBINET TARAUDAGE G ISO 228  
 VÁLVULA A ESFERA MINI HEMBRA G ISO 228 - HEMBRA G ISO 228  
 MINI-VÁLVULA DE ESFERA FÊMEA G ISO 228 - FÊMEA G ISO 228

Code	A	DN	B	C	CH	Pack.
06065 00 001	1/8	6	39	38	21	10
06065 00 002	1/4	8	40	38	21	10
06065 00 003	3/8	8	42	38	21	10
06065 00 004	1/2	10	48	42	25	10
06065 00 005	3/4	12	54	47	30	10

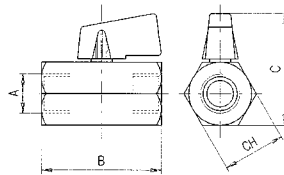

**6066**

**No Gas**

**VALVOLA A SFERA MINI MASCHIO G ISO 228 - FEMMINA G ISO 228**

MINI BALL VALVE MALE G ISO 228 - FEMALE G ISO 228  
 MINI-KUGELHAHN AUSSENGEW. GA ISO 228 - INNENGEW. G ISO 228  
 MINI ROBINET FILETAGE - TARAUDAGE G ISO 228  
 VÁLVULA A ESFERA MINI MACHO G ISO 228 - HEMBRA G ISO 228  
 MINI-VÁLVULA DE ESFERA ROSCA MACHO G ISO 228 - ROSCA FÊMEA G ISO 228

Code	A	DN	B	C	CH	Pack.
06066 00 001	1/8	6	39	38	21	10
06066 00 002	1/4	8	39	38	21	10
06066 00 003	3/8	8	40	38	21	10
06066 00 004	1/2	10	46	42	25	10
06066 00 005	3/4	12	51	47	30	10

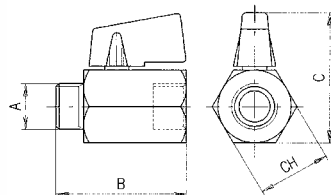

**VALVOLE A SFERA**

**BALL VALVES  
KUGELHÄHNE  
ROBINET A BOISSEAU SPHERIQUE  
VÁLVULAS A ESFERA  
VÁLVULAS DE ESFERA**



**Norma di Riferimento**

Reference standard

Entspricht der Norm

Norme de référence

Normativa de referencia

Norma de referência

1907/2006

REACH ✓

2011/65/CE

RoHS ✓

PED  
2014/68/UE

SILICON  
FREE

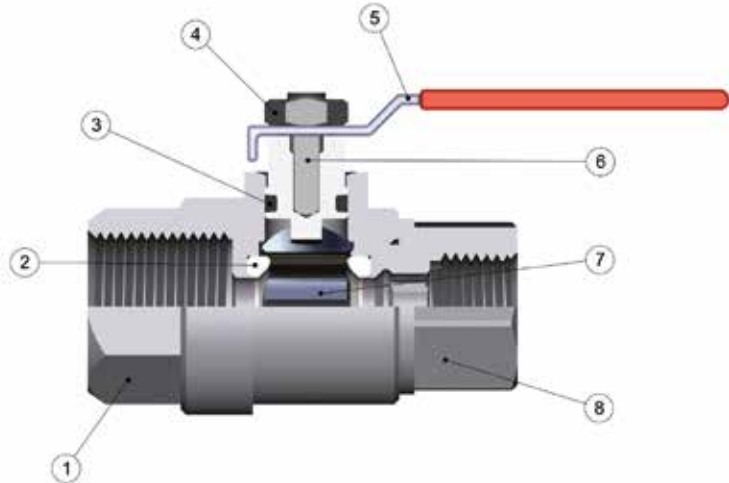

**Materiali e Componenti**

IT

- 1 Corpo in ottone nichelato
- 2 Guarnizione sede sfera in PTFE
- 3 Guarnizione asta: 6068 FKM  
6067/6069 EPDM
- 4 Dado per leva in Acciaio
- 5 Leva di manovra in acciaio plastificato
- 6 Asta di manovra in ottone nichelato
- 7 Sfera in ottone cromato
- 8 Raccordo in Ottone Nichelato

**Component Parts and Materials**

GB

- 1 Nickel-plated Brass Body
- 2 PTFE Seats
- 3 Stem Seal: 6068 FKM  
6067/6069 EPDM
- 4 Steel Nut for lever
- 5 Steel plastified Lever handle
- 6 Nickel-plated Brass Stem
- 7 Chrome Nickel-plated Brass Ball
- 8 Nickel-plated Brass Fitting

**Komponenten und Materialien**

DE

- 1 Körper Messing vernickelt
- 2 Kugelsitzdichtung PTFE
- 3 Spindeldichtung: 6068 FKM  
6067/6069 EPDM
- 4 Hebelmutter Stahl
- 5 Bedienhebel Stahl plastifiziert
- 6 Bedienspindel Messing vernickelt
- 7 Kugel Messing verchromt
- 8 Einschraubkörper Messing vernickelt

**Matériaux et Composants**

FR

- 1 Corps: laiton nickelé
- 2 Joint de forme: PTFE
- 3 Joint de tige: 6068 FKM  
6067/6069 EPDM
- 4 Ecrou de blocage: acier
- 5 Poignée plastifiée: acier
- 6 Tige: laiton nickelé
- 7 Bille: laiton chromé
- 8 Raccord: laiton nickelé

**Materiales y Componentes**

ES

- 1 Cuerpo en latón cromado
- 2 Junta sede esfera PTFE
- 3 Junta eje: 6068 FKM  
6067/6069 EPDM
- 4 Junta para leva en Acero
- 5 Leva de maniobra en acero plastificado
- 6 Eje de maniobra en latón niquelado
- 7 Esfera en latón cromado
- 8 Racor en latón niquelado

**Materiais e Componentes**

PT

- 1 Corpo em Latão Niquelado
- 2 Vedação da sede da esfera em PTFE
- 3 Vedação da haste: 6068 FKM  
6067/6069 EPDM
- 4 Dado per leva em Aço
- 5 Manopla de manobra em aço plastificado
- 6 Haste de manobra em Latão Niquelado
- 7 Esfera em Latão cromado
- 8 Conexões em Latão Niquelado

**DIAGRAMMA PRESSIONE-TEMPERATURA**

PRESSURE-TEMPERATURE RATINGS DIAGRAM  
DRUCK-TEMPERATUR DIAGRAMM  
DIAGRAMME PRESSION / TEMPÉRATURE  
DIAGRAMA PRESIÓN-TEMPERATURA  
DIAGRAMA PRESSÃO-TEMPERATURA

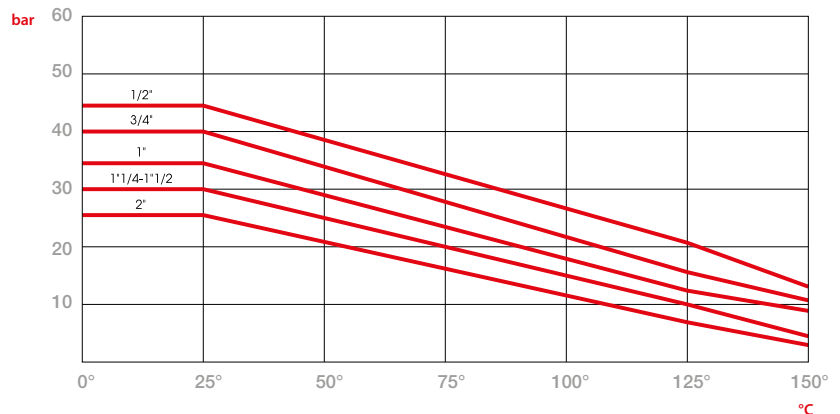

**6067**

**VALVOLA A SFERA, FEMMINA G ISO 228 - FEMMINA G ISO 228**

BALL VALVE, FEMALE G ISO 228 - FEMALE G ISO 228  
 KUGELHAHN, INNENGEW. G ISO 228 - INNENGEW. G ISO 228  
 ROBINET TARAUDAGE G ISO 228  
 VÁLVULA A ESFERA HEMBRA G ISO 228- HEMBRA G ISO 228  
 VÁLVULA DE ESFERA, FÊMEA G ISO 228 - FÊMEA G ISO 228

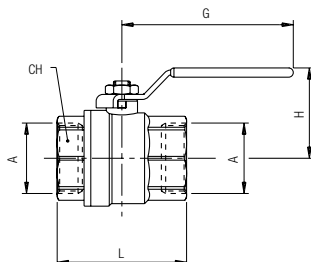

Code	A	DN	CH	L	G	H	Pack.
06067 00 001	1/2	15	25	46	88	47.5	10
06067 00 002	3/4	20	31	56.5	88	51	10
06067 00 003	1"	25	38	65.5	105	63	5
06067 00 004	1 1/4	32	48	77	105	68.5	2
06067 00 005	1 1/2	40	54	88.5	134	84.5	1
06067 00 006	2"	50	67	101.5	134	92.5	1



**Fluidi compatibili**

Aria compressa / Acqua / Oli

**Fluids**

Compressed air / Water / Oils

**Geeignete Medien**

Druckluft / Wasser / Oele

**Fluides compatibles**

Air comprimé / Eau / Huile

**Fluidos compatibles**

Aire comprimido / Agua / Aceite

**Fluidos compatíveis**

Ar comprimido / Água / Óleos

IT

GB

- Fino al DN20:  
Valgono le condizioni riportate nel diagramma
- Dal DN25 al DN50: Pressione Max: 18 bar

- DN 15 and 20:  
Use Diagram condition
- From DN25 to DN50: Max Pressure: 18 bar

DE

FR

- Bis zu DN20:  
Verwenden Sie die Angaben im Diagramm
- Von DN25 bis DN50: Max. Druck: 18 bar

- DN 15 et 20:  
Pour définir la pression maximale, consulter le diagramme
- De DN25 jusqu'à DN50: pression maximum: 18 bar

ES

PT

- Hasta el DN20:  
Ver los valores representados en el diagrama
- Del DN25 al DN50, Presión Máx: 18 bar

- DN15 e DN20:  
Verifique as condições informadas no diagrama
- De DN25 a DN50, Pressão Máx: 18 bar

**6068**

**VALVOLA A SFERA PER GAS, FEMMINA RP ISO7 - FEMMINA RP ISO7**

GAS BALL VALVE, FEMALE RP ISO7 - FEMALE RP ISO7  
 KUGELHAHN FÜR GAS, INNENGEW. RP ISO7 - INNENGEW. RP ISO7  
 ROBINET POUR GAZ - TARAUDAGE RP ISO7  
 VÁLVULA A ESFERA PARA GAS HEMBRA RP ISO7- HEMBRA RP ISO7  
 VÁLVULA DE ESFERA PARA GÁS, ROSCA FÊMEA RP ISO7 - ROSCA FÊMEA RP ISO7

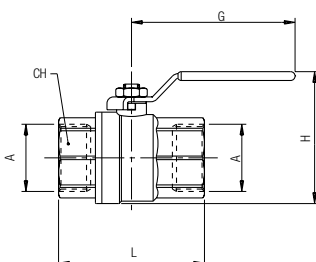

Code	A	DN	CH	L	G	H	Pack.
06068 00 007	1/4	10	22	46	88	50	10
06068 00 008	3/8	12	22	46	88	50	10
06068 00 001	1/2	15	26	59	88	58	10
06068 00 002	3/4	20	32	67.3	88	65	10
06068 00 003	1"	25	40	77.5	105	74	5
06068 00 004	1 1/4	32	49	92	105	85	2
06068 00 005	1 1/2	40	55	101.5	134	100	1
06068 00 006	2"	50	68	122.5	134	116.5	1



**Omologato BS EN 331:1998**

fino a pressione Max: 5 bar.

**Omologated BS EN 331:1998**

to Max pressure: 5bar.

**Zugelassen nach BS EN 331:1998**

bis zu einem max. Druck von 5 bar.

**Homologué BS EN 331:1998**

jusqu'à une pression de: 5bar.

**Homologado BS EN 331:1998**

hasta presión Máx: 5 bar.

**Homologadas BS EN 331:1998**

até a pressão Máx: 5 bar.



**Fluidi**

**Fluids**

Dal DN15 al DN50:  
1° e 2° Famiglia di gas a media pressione e 3° famiglia di gas a bassa pressione.

From DN 15 to 50: Fluids:  
1st and 2nd gas family to medium pressure 3th gas family to low pressure.

**Medien**

**Fluides**

Von DN15 bis DN50:  
1. und 2. Familie von Gasen für Mitteldruck und 3. Familie von Gasen für Niederdruck.

De DN15 jusqu'à DN50:  
1ère et 2ème famille des gaz moyenne pression et 3ème famille des gaz basse pression.

**Fluidos**

**Fluidos**

Del DN15 al DN50:  
1ª y 2ª Familia de gases a media presión y 3ª familia de gas a baja presión.

De DN15 a DN50:  
1º e 2º Familia de gás a média pressão e 3º família de gás a baixa pressão.

**6069**

**VALVOLA A SFERA MASCHIO G ISO 228 - FEMMINA G ISO 228**

BALL VALVE MALE G ISO 228 - FEMALE G ISO 228

KUGELHAHN, AUSSENGEW. G ISO 228 - INNENGEW. G ISO 228

ROBINET, FILETAGE G ISO 228 - TARAUDAGE G ISO 228

VÁLVULA A ESFERA MACHO G ISO 228 - HEMBRA G ISO 228

VÁLVULA DE ESFERA ROSCA MACHO G ISO 228 - ROSCA FÊMEA G ISO 228

Code	A	B	DN	CH	L	G	H	Pack.
06069 00 001	1/2	1/2	15	25	56	88	47.5	10
06069 00 002	3/4	3/4	20	31	63.5	88	51	10
06069 00 003	1"	1"	25	38	74	105	63	5
06069 00 004	1 1/4	1 1/4	32	48	85	105	68.5	2
06069 00 005	1 1/2	1 1/2	40	54	100	134	84.5	1
06069 00 006	2"	2"	50	67	121.5	134	92.5	1

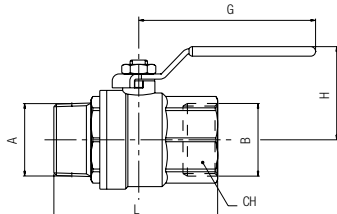

**Fluidi compatibili**

Aria compressa / Acqua / Oli

**Fluids**

Compressed air / Water / Oils

**Geeignete Medien**

Druckluft / Wasser / Oele

**Fluides compatibles**

Air comprimé / Eau / Huile

**Fluidos compatibles**

Aire comprimido / Agua / Aceite

**Fluidos compatíveis**

Ar comprimido / Água / Óleos

	IT	GB
	<ul style="list-style-type: none"> <li>Fino al DN20: Valgono le condizioni riportate nel diagramma.</li> <li>Dal DN25 al DN50: Pressione Max: 18 bar</li> </ul>	<ul style="list-style-type: none"> <li>DN 15 and 20: Use Diagram condition.</li> <li>From DN25 to DN50: Max Pressure: 18 bar</li> </ul>
	DE	FR
	<ul style="list-style-type: none"> <li>Bis zu DN20: Verwenden Sie die Angaben im Diagramm.</li> <li>Von DN25 bis DN50: Max. Druck: 18 bar</li> </ul>	<ul style="list-style-type: none"> <li>DN 15 et 20: Pour définir la pression maximale, consulter le diagramme.</li> <li>De DN25 jusqu'à DN50: pression maximum: 18 bar</li> </ul>
	ES	PT
	<ul style="list-style-type: none"> <li>Hasta el DN20: Ver los valores representados en el diagrama.</li> <li>Del DN25 al DN50, Presión Máx: 18 bar</li> </ul>	<ul style="list-style-type: none"> <li>DN15 e DN20: Verifique as condições informadas no diagrama.</li> <li>De DN25 a DN50, Pressão Máx: 18 bar</li> </ul>

**New**

**VALVOLA A SFERA A 3 VIE PASSAGGIO A "T" E A "L"**

3 WAYS BALL VALVES FEMALE - "T" & "L"  
 3-WEGE KUGELHAHN MIT "L" UND "T" BOHRUNG  
 ROBINET A 3 VOIES PASSAGE EN "T" ET EN "L"  
 VÁLVULA DE ESFERA A 3 VÍAS PASO A "T" Y A "L"  
 VÁLVULA ESFERA 3 VIAS COM PASSAGEM "T" E "L"

**CARATTERISTICHE TECNICHE**  
 TECHNICAL CHARACTERISTICS  
 TECHNISCHE ANGABEN  
 CARACTÉRISTIQUES TECHNIQUES  
 CARACTERÍSTICAS TÉCNICAS  
 CARACTERÍSTICAS TÉCNICAS

**Norma di Riferimento**  
 Reference standard  
 Entspricht der Norm  
 Norme de référence  
 Normativa de referencia  
 Norma de referència

1907/2006 REACH ✓  
 2011/65/CE RoHS ✓  
 PED 2014/68/UE  
 SILICON FREE

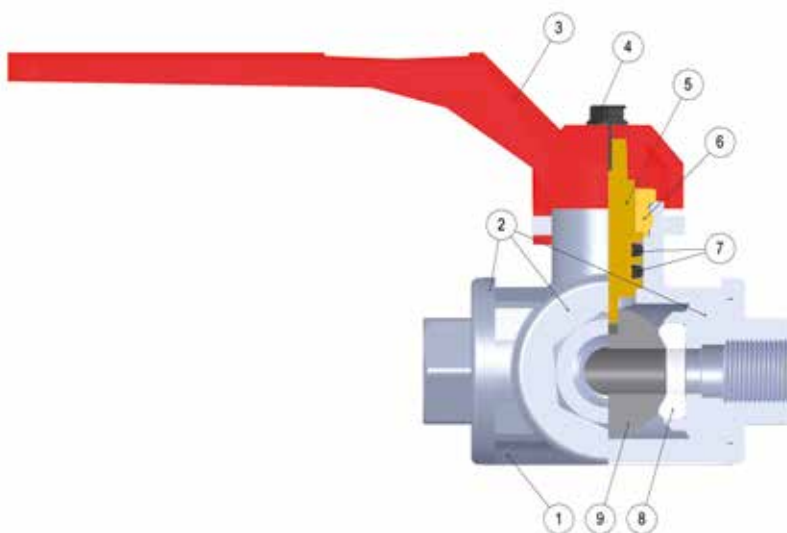

Materiali e Componenti	IT	Component Parts and Materials	GB	Komponenten und Materialien	DE
1 Corpo in ottone nichelato		1 Nickel-plated brass body		1 Körper Messing vernickelt	
2 Raccordi in ottone nichelato		2 Nickel-plated brass adaptors		2 Anschlüsse Messing vernickelt	
3 Leva in alluminio EN-AB46100		3 Aluminum handle EN-AB46100		3 Griff Aluminium EN-AB46100	
4 Vite acciaio zincato		4 Zinc plated screw		4 Schraube Stahl verzinkt	
5 Asta di manovra in ottone giallo		5 Handling needle in yellow brass		5 Spindel Messing	
6 Premiguarnizione in ottone giallo		6 Seal locker in yellow brass		6 Hülse Messing	
7 Guarnizione asta FKM		7 Needle seal FKM		7 Dichtung Spindel FKM	
8 Guarnizione sede sfera in PTFE		8 Ball seat seal PTFE		8 Kugelsitzdichtung PTFE	
9 Sfera in ottone cromato		9 Chrome-plated brass ball		9 Kugel Messing verchromt	
Matériaux et Composants	FR	Materiales y Componentes	ES	Materiais e Componentes	PT
1 Corps en laiton nickelé		1 Cuerpo en latón niquelado		1 Corpo em latão niquelado	
2 Raccordement en laiton nickelé		2 Racores en latón niquelado		2 Conexões em latão niquelado	
3 Poignée en aluminium EN-AB46100		3 Leva en aluminio EN-AB46100		3 Alavanca em alumínio EM-AB46100	
4 Vis en acier zing ué		4 Tornillo en acero zincado		4 Parafusos em aço zincado	
5 Tige en laiton		5 Eje de maniobra en latón natural		5 Haste de manobra em latão amarelo	
6 Axe de tige en laiton		6 Sujeta eje en latón natural		6 Prensa-vedações em latão amarelo	
7 Joint de tige en FKM		7 Junta eje en FKM		7 Vedações da haste em FKM	
8 Joint de forme en PTFE		8 Junta sede esfera en PTFE		8 Vedações da base da esfera em PTFE	
9 Bille laiton chromé		9 Esfera en latón cromado		9 Esfera em latão cromado	



**Temperature**

Temperatures

Temperatur

Températures

Temperaturas

Temperaturas

- 10 °C

+ 120 °C



**Fluidi compatibili**

Aria compressa / Vuoto / Acqua / Oli

**Fluids**

Compressed air / Vacuum / Water / Oils

**Geeignete Medien**

Druckluft / Vakuum / Wasser / Oel

**Fluides compatibles**

Air comprimé / Vide / Eau / Huile

**Fluidos compatibles**

Aire comprimido / Vacío / Agua / Aceite

**Fluidos compatíveis**

Ar comprimido / Vácuo / Água / Óleos



**Diagramma Pressione - Temperatura**

Pressure - Temperature ratings diagram

Druck - Temperatur diagramm



Diagramme Pression - Température

Diagrama Presión - Temperatura

Diagrama de Pressão - Temperatura

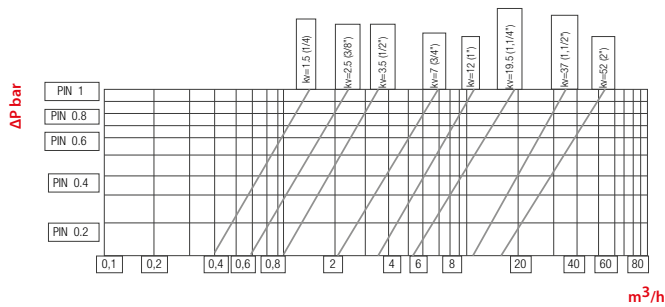
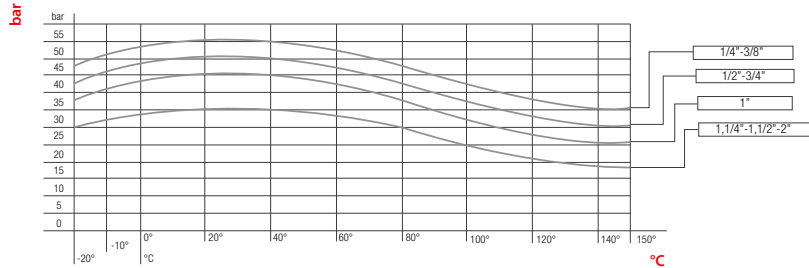

**Attenzione**

IT

La presente valvola deve essere impiegata alle condizioni esposte in questa scheda, e dalla misura 1 - 1/4" e superiori, non deve essere utilizzata per fluidi pericolosi quali: esplosivi, infiammabili, tossici e comburenti.

**Attention**

GB

This valve must be used at the above described conditions. From size 1-1/4" and bigger, do not use with dangerous fluids: explosives, inflammables, inflammables, toxic and combusive.

**Achtung**

DE

Dieses Ventil muss unter den in diesem Anhang angegebenen Bedingungen verwendet werden. Die Abmessungen 1 1/4" und grösser, dürfen nicht für gefährliche Flüssigkeiten verwendet werden, wie zum Beispiel: hochexplosive, entzündliche, giftige und oxidierende.

**Attention**

FR

Ces robinets doivent être utilisée dans le tableau ci dessus. A partir de 1 - 1/4 " ils ne doivent pas être utilisés pour des fluides dangereux (explosifs, produits inflammables, produits toxiques...).

**Atención**

ES

La presente válvula debe ser utilizada a las condiciones expuestas en esta tabla, y desde la medida 1 - 1/4" y superior, no debe ser utilizada para fluidos peligrosos tales como: explosivos, inflamables, tóxicos y oxidantes.

**Atenção**

PT

A presente válvula deve ser aplicada às condições expostas neste tabela, e nas medidas 1-1/4" e superiores não deve ser utilizada para fluidos perigosos, tais como: explosivos, inflamáveis, tóxicos e comburentes.



**Filettatura**

IT

Gas cilindrica conforme ISO 228 Classe A.

**Threads**

GB

Parallel gas in conformity with ISO 228 Class A.

**Gewindearten**

DE

Zylindrisches Gewinde nach Norm ISO 228 Classe A.

**Filetages**

FR

Filetage cylindrique conforme: ISO 228 Classe A.

**Roscas**

ES

Gas cilindrica conforme ISO 228 Clase A.

**Roscas**

PT

Gas paralela conforme ISO 228 Classe A.

**6074**

**New**

**VALVOLA 3 VIE A L FEMMINA G ISO 228**

3 WAYS BALL VALVE "L" FEMALE G ISO 228  
 3-WEGE WINKEL-KUGELHAHN INNENGEW. G ISO 228  
 ROBINET 3 VOIES EN L TARAUDEE G ISO 228  
 VÁLVULA 3 VIAS A L HEMBRA G ISO 228  
 VÁLVULA 3 VIAS EM "L" ROSCA FÊMEA G ISO 228

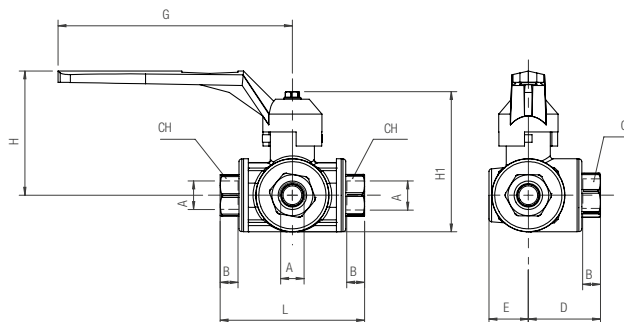
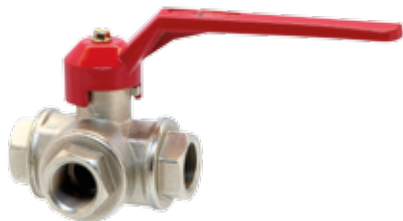

Code	A	B	D	E	F	G	H	CH	DN	PN 20°/40 °C	Pack.
06074 VO 001	1/4	65	38,5	77	125	75	22	22	10	55	2
06074 VO 002	3/8	65	38,5	77	125	75	22	22	12	55	2
06074 VO 003	1/2	65	38,5	77	125	75	22	27	14	50	2
06074 VO 004	3/4	83	46	92	145	91	25	34	18	50	2
06074 VO 005	1"	96	52	104	170	105	30	41	23	45	2
06074 VO 006	1" - 1/4	102	59	118	170	115	34	50	29	35	1
06074 VO 007	1" - 1/2	109	69	138	170	128	40	57	36	35	1
06074 VO 008	2"	139	81	162	260	165	48	70	45	35	1

**Funzionamento valvola a L**

**IT**

A maniglia smontata è visibile, sull'asta di manovra, un incavo a forma di L che indica il senso di esecuzione dei fori della sfera, permettendo le seguenti combinazioni:

**L valve - Function**

**GB**

With disassembled handle, an L-shaped cavity on the handling needle will show the turning way of the ports. Combinations are followings:

**Funktion Winkelkugelhahn**

**DE**

Bei abmontiertem Griff ist auf der Spindel eine L-förmige Aussparung sichtbar, welche die Laufrichtung der Kugellöcher zeigt. Folgende Kombinationen sind möglich:

**Funcionnement de la vanne en L**

**FR**

La poignée démontable et la bille percée en L permettent les combinaisons suivantes:

**Funcionamiento válvula a L**

**ES**

Con la maneta desmontada es visible, sobre el eje de maniobra un rebaje en forma de L que indica el sentido de ejecución de los agujeros de la esfera, permitiendo las siguientes combinaciones:

**Funcionamento da válvula com saída em L**

**PT**

Com a manopla desmontada, na haste de manobra fica visível uma cavidade em forma de L, que indica o sentido de funcionamento dos orifícios da esfera, permitindo as seguintes combinações:

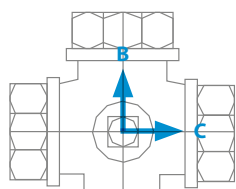

**Il flusso passa da B a C (o viceversa)**

Flow from B to C (or reverse)  
 Der Durchfluss verläuft von B nach C (oder umgekehrt)  
 Passage du fluide de B vers C (et inversement)  
 El flujo pasa de B a C (o viceversa)  
 O fluxo passa de B para C (ou vice-versa)

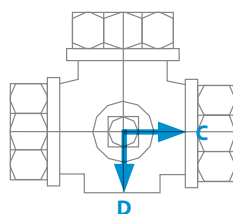

**Il flusso è interrotto**

Flow is stopped  
 Der Durchfluss wird unterbrochen  
 Passage ferme  
 El flujo es interrumpido  
 O fluxo é interrompido

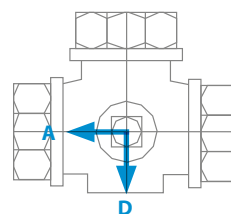

**Il flusso è interrotto**

Flow is stopped  
 Der Durchfluss wird unterbrochen  
 Passage ferme  
 El flujo es interrumpido  
 O fluxo é interrompido

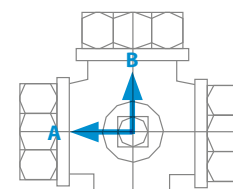

**Il flusso passa da A a B (o viceversa)**

Flow from A to B (or reverse)  
 Der Durchfluss verläuft von A nach B (oder umgekehrt)  
 Passage du fluide de A vers B (et inversement)  
 El flujo pasa de A a B (o viceversa)  
 O fluxo passa de A para B (ou vice-versa)

**6075**

**New**

**VALVOLA 3 VIE A T FEMMINA G ISO 228**

3 WAYS BALL VALVE "T" FEMALE G ISO 228  
 3-WEGE T-KUGELHAHN INNENGEW. G ISO 228  
 ROBINET 3 VOIES EN T TARAUEE G ISO 228  
 VÁLVULA 3 VIAS A T HEMBRA G ISO 228  
 VÁLVULA 3 VIAS EM "T" ROSCA FÊMEA G ISO 228

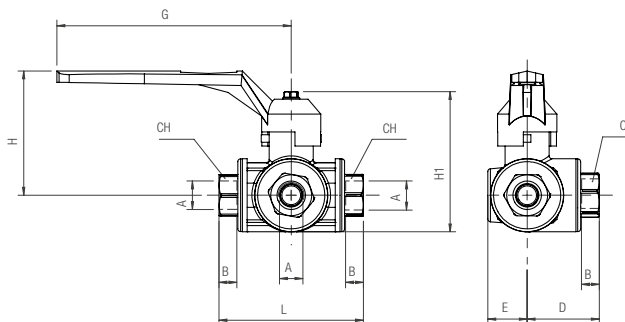

Code	A	B	D	E	F	G	H	CH	DN	PN 20°/40 °C	Pack.
06075 V0 001	1/4	65	38,5	77	125	75	22	22	10	55	2
06075 V0 002	3/8	65	38,5	77	125	75	22	22	12	55	2
06075 V0 003	1/2	65	38,5	77	125	75	22	27	14	50	2
06075 V0 004	3/4	83	46	92	145	91	25	34	18	50	2
06075 V0 005	1"	96	52	104	170	105	30	41	23	45	2
06075 V0 006	1" - 1/4	102	59	118	170	115	34	50	29	35	1
06075 V0 007	1" - 1/2	109	69	138	170	128	40	57	36	35	1
06075 V0 008	2"	139	81	162	260	165	48	70	45	35	1

**Funzionamento valvola a T**

**IT**

A maniglia smontata è visibile, sull'asta di manovra, un incavo a forma di T che indica il senso di esecuzione dei fori della sfera, permettendo le seguenti combinazioni:

**T valve - Function**

**GB**

With disassembled handle, an T-shaped cavity on the handling needle will show the turning way of the ports. Combinations are following:

**Funktion T-Kugelhahn**

**DE**

Bei abmontiertem Griff ist auf der Spindel eine T-förmige Aussparung sichtbar, welche die Laufrichtung der Kugellöcher zeigt. Folgende Kombinationen sind möglich:

**Funcionnement de la vanne en T**

**FR**

La poignée démontable et la bille percée en T permettent les combinaisons suivantes:

**Funcionamiento válvula a T**

**ES**

Con la maneta desmontada es visible, sobre el eje de maniobra, un rebaje en forma de T que indica el sentido de ejecución de los agujeros de la esfera, permitiendo las siguientes combinaciones:

**Funcionamento da válvula com saída em T**

**PT**

Com a manopla desmontada é visível, na haste de manobra, uma cavidade em forma de T que indica o sentido normal de funcionamento dos furos da esfera, permitindo a as seguintes combinações:

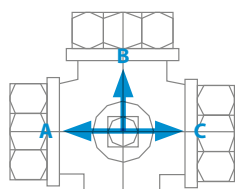

**Il flusso passa in tutte le tre direzioni (A-B-C)**

Flow to all directions (A-B-C)  
 Der Durchfluss verläuft in alle drei Richtungen (A-B-C)  
 Passage du fluide dans les trois directions (A-B-C)  
 El flujo pasa en todas las tres direcciones (A-B-C)  
 O fluxo passa em todas as três direções (A-B-C)

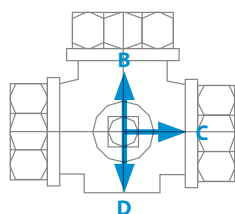

**Il flusso passa solamente da B a C (o viceversa)**

Flow only from B to C (or reverse)  
 Der Durchfluss verläuft nur von B nach C (oder umgekehrt)  
 Passage du fluide de B vers C (et inversement)  
 El flujo pasa solamente de B a C (o viceversa)  
 O fluxo passa somente de B para C (ou vice-versa)

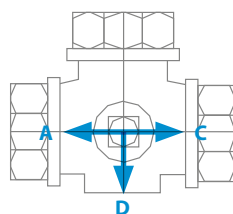

**Il flusso passa solamente da A a C (o viceversa)**

Flow only from A to C (or reverse)  
 Der Durchfluss verläuft nur von A nach C (oder umgekehrt)  
 Passage du fluide de A vers C (et inversement)  
 El flujo pasa solamente de A a C (o viceversa)  
 O fluxo passa somente de A para C (ou vice-versa)

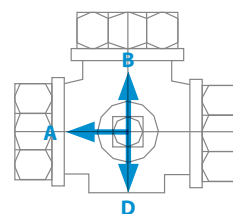

**Il flusso passa solamente da A a B (o viceversa)**

Flow only from A to B (or reverse)  
 Der Durchfluss verläuft nur von A nach B (oder umgekehrt)  
 Passage du fluide de A vers B (et inversement)  
 El flujo pasa solamente de A a B (o viceversa)  
 O fluxo passa somente de A para B (ou vice-versa)



**FILTRO A Y**

Y FILTER  
Y FILTER  
FILTRE Y  
FILTRO A Y  
FILTRO Y

Materiali e Componenti	IT	Component Parts and Materials	GB	Komponenten und Materialien	DE
<ul style="list-style-type: none"> <li>Corpo in ottone dal 1/4 al 2"</li> <li>Corpo in bronzo dal 2"1/2 al 4"</li> <li>Tappo in ottone</li> <li>Filtro in acciaio AISI 304</li> <li>Guarnizione corpo in NBR</li> </ul>		<ul style="list-style-type: none"> <li>Brass body from 1/4 to 2"</li> <li>Bronze body from 2"1/2 to 4"</li> <li>Brass Cap</li> <li>Steel AISI 304 Strainer</li> <li>NBR Body Seal</li> </ul>		<ul style="list-style-type: none"> <li>Körper Messing von 1/4 bis 2"</li> <li>Körper Bronze von 2"1/2 bis 4"</li> <li>Verschlussdeckel Messing</li> <li>Filter Edelstahl AISI 304</li> <li>Körperdichtung NBR</li> </ul>	
Matériaux et Composants	FR	Materiales y Componentes	ES	Materiais e Componentes	PT
<ul style="list-style-type: none"> <li>Corps en laiton de 1/4 à 2"</li> <li>Corps en bronze de 2"1/2 à 4"</li> <li>Bouchon en laiton</li> <li>Filtre inox AISI 304</li> <li>Joint de corps: NBR</li> </ul>		<ul style="list-style-type: none"> <li>Cuerpo en latón de 1/4 a 2"</li> <li>Cuerpo en Bronce 2"1/2 a 4"</li> <li>Tapón en latón</li> <li>Filtro en acero AISI 304</li> <li>Junta cuerpo en NBR</li> </ul>		<ul style="list-style-type: none"> <li>Corpo em latão de 1/4 al 2"</li> <li>Corpo em bronze de 2"1/2 al 4"</li> <li>Tampão em latão</li> <li>Filtro em aço AISI 304</li> <li>Vedação corpo em NBR</li> </ul>	

Bar	Pressione massima
	Maximum Pressure
	Maximaler Betriebsdruck
	Pression maximum
	Presión máxima
	Pressão máxima
	<b>1/4 ÷ 2"                    20 bar</b>
	<b>2" - 1/2 ÷ 4"            16 bar</b>

	Temperatura di esercizio in assenza di vapore
	Working temperature without steam
	Betriebstemperatur ohne Dampf
	Température d'utilisation sans vapeur
	Temperatura de ejercicio con ausencia de vapor
	Temperatura de trabalho sem presença de vapor
	<b>- 20 °C</b>
	<b>+ 110 °C</b>

✓	Soglia di filtrazione
	Filtration degree
	Filterfeinheit
	Degré de filtration
	Grado de filtración
	Grau de filtragem
	<b>1/4 ÷ 2"                    500 µm</b>
	<b>2"1/2 - 3" - 4"        800 µm</b>

⊞	Fluidi compatibili
	Acqua / Oli / Aria
	Fluids
	Water / Oils / Air
	Geeignete Medien
	Wasser / Oel / Air
	Fluides compatibles
	Eau / Huile / Air
	Fluidos compatibles
	Agua / Aceite / Aire
	Fluidos compatíveis
	Água / Óleo / Ar

⊞	Filettatura	IT
	Gas cilindrica conforme ISO 228 Classe A.	
Threads		GB
	Parallel gas in conformity with ISO 228 Class A.	
Gewindearten		DE
	Zylindrisches Gewinde nach Norm ISO 228 Classe A.	
Filetages		FR
	Filetage cylindrique conforme: ISO 228 Class A.	
Roscas		ES
	Gas cilíndrica conforme ISO 228 Clase A.	
Roscas		PT
	Gas paralela conforme ISO 228 Classe A.	

**6035**

FILTRO "Y"  
"Y" FILTER  
"Y" FILTER  
FILTRE "Y"  
FILTRO "Y"  
FILTRO "Y"

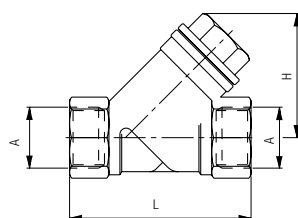

Code	A	DN	L	H	PN	KV	Pack.
06035 00 001	1/4	8	55	40	20	2,2	10
06035 00 002	3/8	10	55	40	20	3,4	10
06035 00 003	1/2	15	58	40	20	4,5	10
06035 00 004	3/4	20	70	50	20	7,9	10
06035 00 005	1"	25	87	56	20	11	5
06035 00 006	1"1/4	32	96	64	20	16	2
06035 00 007	1"1/2	40	106	73	20	22	2
06035 00 008	2"	50	126	89	20	35	1
06035 00 009	2"1/2	65	150	107	16	60	1
06035 00 010	3"	80	170	120	16	83	1
06035 00 011	4"	100	219	161	16	100	1

**VALVOLE DI RITEGNO**

NO RETURN VALVE  
RÜCKSCHLAGVENTIL  
CLAPET ANTI-RETOUR  
VÁLVULA DE RETENCIÓN  
VÁLVULAS ANTI-RETORNO



**CARATTERISTICHE TECNICHE**

TECHNICAL CHARACTERISTICS  
TECHNISCHE ANGABEN  
CARACTÉRISTIQUES TECHNIQUES  
CARACTERÍSTICAS TÉCNICAS  
CARACTERÍSTICAS TÉCNICAS



**Norma di Riferimento**

Reference standard

Entspricht der Norm

Norme de référence

Normativa de referencia

Norma de referência

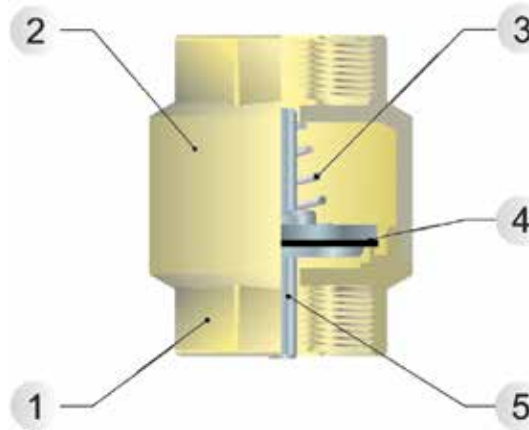

**Materiali e Componenti**

**IT**

- 1 Corpo in Ottone
- 2 Coperchio in Ottone
- 3 Molla in acciaio inox
- 4 Guarnizione in NBR
- 5 Otturatore in plastica

**Component Parts and Materials**

**GB**

- 1 Brass Body
- 2 Brass Cover Cap
- 3 Stainless steel Spring
- 4 NBR Seal
- 5 Plastic Shutter

**Komponenten und Materialien**

**DE**

- 1 Körper Messing
- 2 Einschraubkörper Messing
- 3 Feder Edelstahl
- 4 Dichtung NBR
- 5 Verschluss Kunststoff

**Matériaux et Composants**

**FR**

- 1 Corps: laiton
- 2 Corps: laiton
- 3 Ressort: inox
- 4 Joint: NBR
- 5 Obturateur: plastique

**Materiales y Componentes**

**ES**

- 1 Cuerpo en latón
- 2 Cuerpo en latón
- 3 Muelle en Acero Inox
- 4 Junta en NBR
- 5 Obturador en material plástico

**Materiais e Componentes**

**PT**

- 1 Corpo em Latão
- 2 Cobertura em Latão
- 3 Mola em aço inox
- 4 Vedação em NBR
- 5 Obturador em plástico



**Pressioni**

Pressures

Druckbereich

Pressions

Presiones

Pressões

DN	
3/8 ÷ 1"	1"-1/4 ÷ 2"
<b>12 bar</b>	<b>10 bar</b>



**Temperature**

Temperatures

Temperatur

Températures

Temperaturas

Temperaturas

0 °C  
+ 90 °C



**Fluidi compatibili**

Aria compressa / Acqua / Oli

Fluids

Compressed air / Water / Oils

Geeignete Medien

Druckluft / Wasser / Oel

Fluides compatibles

Air comprimé / Eau / Huile

Fluidos compatibles

Aire comprimido / Agua / Aceite

Fluidos compatíveis

Ar comprimido / Água / Óleo

## 6036

### VALVOLA DI RITEGNO

NON RETURN VALVE  
RÜCKSCHLAGVENTIL  
CLAPET ANTI-RETOUR  
VÁLVULA DE RETENCIÓN  
VÁLVULA ANTI-RETORNO

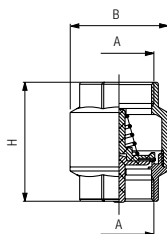

Code	A	H	B	Pack.
06036 00 007	3/8	49	34	10
06036 00 001	1/2	49	34	10
06036 00 002	3/4	54	42	5
06036 00 003	1"	59	48	5
06036 00 004	1"1/4	67	60	2
06036 00 005	1"1/2	72	69	2
06036 00 006	2"	77	85	1

## 6037

### VALVOLA DI FONDO

FINAL VALVE  
ENDVENTIL  
CLAPET ANTI RETOUR DE FIN DE LIGNE  
VÁLVULA DE FONDO  
VÁLVULA DE FUNDO

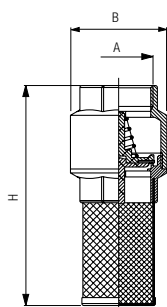

Code	A	H	B	Pack.
06037 00 001	1/2	81	34	10
06037 00 002	3/4	87	42	5
06037 00 003	1"	97	48	5
06037 00 004	1"1/4	110	60	4
06037 00 005	1"1/2	125	69	2
06037 00 006	2"	145	85	1



Soglia di filtrazione - Filtration threshold - Filterfeinheit  
Capacité de filtration - Grado de filtración - Limite de filtragem

**1.000 µm**

## 6038

### FILTRO IN RETE STIRATA

STRECHED NET FILTER  
NETZFILTER  
FILTRE  
FILTRO EN RED ESTIRADA  
FILTRO DE TELA PARA VÁLVULA DE FUNDO

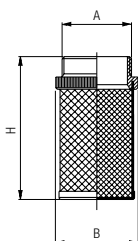

Code	A	H	B	Pack.
06038 00 002	1/2	50	28	10
06038 00 003	3/4	56	33	5
06038 00 004	1"	58	41	5
06038 00 005	1"1/4	69	50	5
06038 00 006	1"1/2	78	55	5
06038 00 007	2"	96	67	1



Soglia di filtrazione - Filtration threshold - Filterfeinheit  
Capacité de filtration - Grado de filtración - Limite de filtragem

**1.000 µm**

